

# ELECTRICAL MACHINES

## REFERENCES:

1. D. BROWN & E. P. HAMILTON "ELECTROMECHANICAL ENERGY CONVERSION" MACMILLAN, NY 1984.
2. H. COTTON "ADVANCED ELECTRICAL TECHNOLOGY" PITMAN, LONDON 1967.
3. A. R. DANIELS "INTRODUCTION TO ELECTRICAL MACHINES" MACMILLAN, LONDON 1976.
4. A. DRAPER "ELECTRICAL CIRCUITS- INCLUDING MACHINES" LONGMAN, LONDON 1972.
5. A. DRAPER "ELECTRICAL MACHINES" 2<sup>ND</sup> EDITION, LONGMAN, LONDON.
6. A. E. FITZGERALD, D. E. HIGGINBOTTOM, & A. GABRIEL "BASIC ELECTRICAL ENGINEERING" 5<sup>TH</sup> ED. MCGRAW-HILL, NY 1981.
7. A. E. FITZGERALD, C. KINGSLEY, & S. D. UMANS "ELECTRICAL MACHINERY", 4<sup>TH</sup> ED. MCGRAW-HILL, TOKYO 1983.
8. J. HINDMARSH "ELECTRICAL MACHINES AND THEIR APPLICATIONS" 4<sup>TH</sup> ED. PERGAMON, OXFORD 1984.
9. E. HUGHES "ELECTRICAL TECHNOLOGY" LONGMANS, LONDON.
10. G. MCPHERSON "AN INTRODUCTION TO ELECTRICAL MACHINES AND TRANSFORMERS" WILEY, NY 1981.
11. S. A. NASAR "ELECTRIC MACHINES AND ELECTROMECHANICS" MCGRAW-HILL(SCHAUM), NY 1981.
12. S. A. NASAR & L. E. UNNEWEHR "ELECTROMECHANICS AND ELECTRIC MACHINES", 2<sup>ND</sup> ED. WILEY, NY 1983.
13. J. ROSENBLATT & M. H. FRIEDMAN "DIRECT AND ALTERNATING CURRENT MACHINERY" 2<sup>ND</sup> ED. MERRILL, COLOMBUS OHIO 1984.
14. Theraja BI, Theraja Ak "ELECTRICAL TECHNOLOGY" .
15. A. S. LANGSDORF "THEORY OF ALTERNATING CURRENT MACHINERY" 2<sup>ND</sup> ED. MCGRAW-HILL, NY 1955. **DC MACHINES ONLY :**
16. A. E. CLAYTON & N. M. HANCOCK "THE PERFORMANCE AND DESIGN OF DIRECT CURRENT MACHINES" 3<sup>RD</sup> ED. PITMAN, LONDON 1959.
17. M. G. SAY & E. O. TAYLOR "DIRECT CURRENT MACHINES" PITMAN, LONDON 1980.

## CHAPTER 1 :

**PRINCIPLE OF OPERATION****-1.1 SOME BASIC RULES**

Right-hand screw rule (cross product operation in vector algebra)

$$A_1 \times A_2 = A_3$$

$A_1$ ,  $A_2$ , and  $A_3$  are vectors. Rotate RH fingers from the direction of the first vector,  $A_1$ , to the direction of the second vector,  $A_2$ , through the small angle ( $<180^\circ$ ) between them; the direction of  $A_3$  is then given by the extended RH thumb. In our applications, the magnetic field  $B$  is always the second vector.

Given a straight conductor lying in a magnetic field, and oriented perpendicular to the direction of the field. Let

$B$ = magnetic flux density (also called magnetic induction), [T=tesla=weber/m<sup>2</sup>];

$L$ =active length of conductor,[m].       $u$



Induced voltage (emf):       $E = B \cdot L \cdot u \cdot \sin \alpha$  volts

$u$ = speed of conductor perpendicular to its length[m/s];

$\alpha$ = small angle from  $u$  to  $B$ .

Direction of  $E$  : RH screw rule from  $u$  to  $B$  .

Developed force :       $F_d = B \cdot I \cdot L$  newtons [N]

$I$ = current through conductor, [A].

Direction of  $F_d$  : RH screw rule from  $I$  to  $B$ .

-1.2 Single conductor

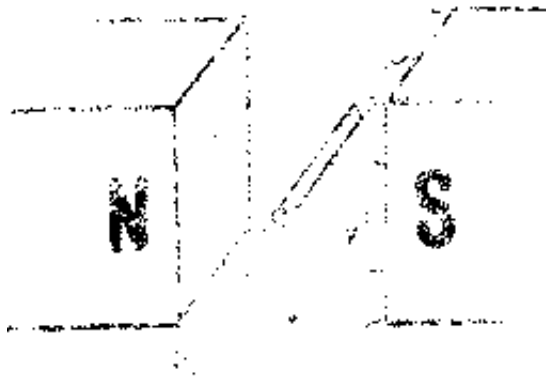

Consider a straight conductor moving at a uniform speed  $u$  in a uniform magnetic field  $B$ , and carrying a current  $I$ . Let

$L$  = active length (i.e. length of conductor segment immersed in the field);

$F_m$  = applied mechanical force, [N].

$u$  &  $B$  give  $E = B \cdot L \cdot u$  and  $I$  &  $B$  give  $F_d = B \cdot I \cdot L$

$E \cdot I = (B \cdot L \cdot u) \cdot I = (B \cdot I \cdot L) \cdot u = F_d \cdot u \rightarrow E \cdot I = F_d \cdot u = P_c = \text{conversion power}$

Note: Because the speed  $u$  is constant,  $F_d$  and  $F_m$  must be equal and opposite (otherwise there would be acceleration or deceleration).

$E \cdot I$  is electrical power, and  $F_d \cdot u$  ( $F_m \cdot u$ ) is mechanical power.



$I$  in direction of  $E$ ;  $F_d$  opposite to  $u$ .       $I$  opposite to  $E$ ;  $F_d$  in Direction of  $u$ .

Generation action.

Motor action

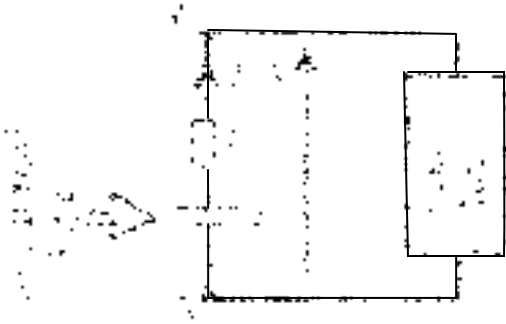

$$V = E - I.R$$

$$P_{in} = \frac{\Delta W_m}{\Delta t} = \frac{F_m \Delta S}{\Delta t}$$

$$= F_d \cdot u = P_c$$

$P_{cu}$  = copper losses

$$P_{out} = V.I = (E - I.R).I$$

$$= E.I - I^2.R = P_c - P_{cu}$$

$$= P_{in} - P_{cu}$$

$$P_{in} - P_{out} = P_{cu}$$

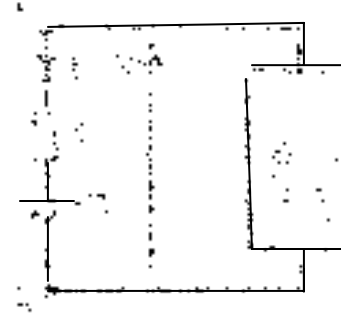

$$V = E + I.R$$

$$P_{in} = V.I = (E + I.R).I$$

$$= E.I + I^2.R = P_c + P_{cu}$$

$$P_{out} = \frac{\Delta W_m}{\Delta t} = \frac{F_m \Delta S}{\Delta t}$$

$$= F_d \cdot u = P_c$$

$$P_{in} = P_{out} + P_{cu}$$

$$P_{in} - P_{out} = P_{cu}$$

### -1.3 Wire loop

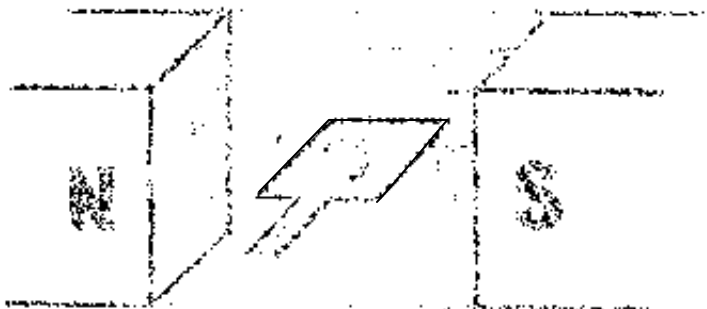

Consider now a wire loop rotating at a uniform speed in a magnetic field  $B$ . Conductors  $a$  and  $b$  are the active parts of the loop; the remaining parts are 'end-connections' and 'leads'.

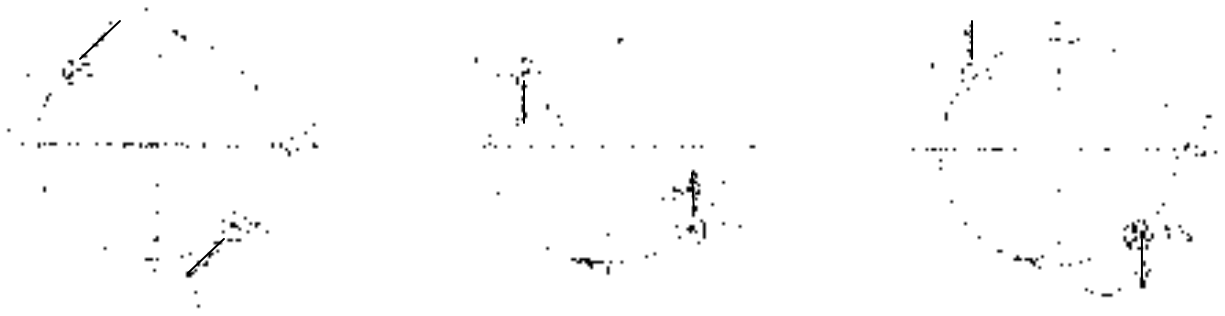

$F_{da} = F_{db}$  zero resultant force  $T_d =$  developed torque

$i$  in direction of  $e$  ;  $T_d$  opposes rotation  $i$  opposes  $e$  ;  $T_d$  aids rotation

Generator action.

Motor action.

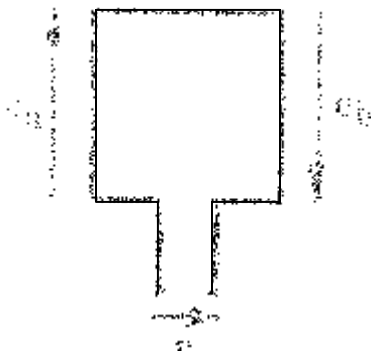

KVL:  $e = e_a + e_b =$  loop emf

-1.4 **Slip rings**

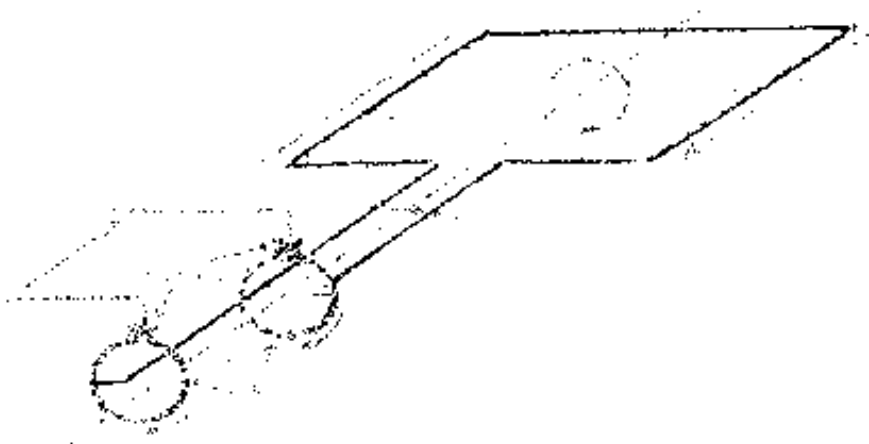

Slip rings and brushes may be used to make electrical contact with a rotating loop. Slip rings rotate with loop, while brushes are stationary to give sliding contact. A slip ring and a brush for each terminal.

The induced emf is alternating, and the developed torque oscillates (about the vertical position). Clearly, slip rings are not suitable for dc machines (they are used in ac machines).

### -1.5 Commutator

A commutator is a conducting ring split into segments; each segment is electrically connected to one terminal of the loop. It is mounted on the shaft, but is electrically insulated from it. The brushes are stationary and make sliding contact with the segments. The

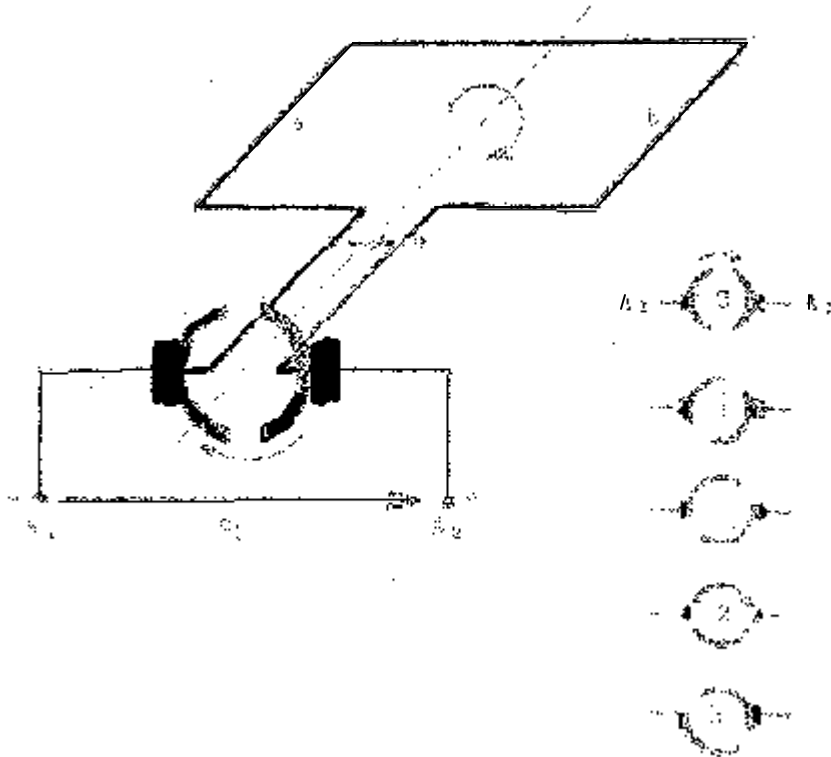

$A_2$  is always positive;  $A_1$  is always negative:  $\gg e_t$  is always positive, &  $T_d$  is always CW (when direct current supplied to brushes), but emf & current within loop oscillate. Although  $e_t$  and  $T_d$  are now unidirectional (i.e. remain in the same direction or sense), they do not represent steady dc operation because they fluctuate: each is maximum when the loop is in position 0, and zero when it is in position 2.

### -1.6 Multiple loops

More uniform dc operation is achieved by using a number of loops displaced from each other in space. The emf's add (series connection), and the developed torques aid each other. As the number of loops is increased, ideal dc operation is approached.

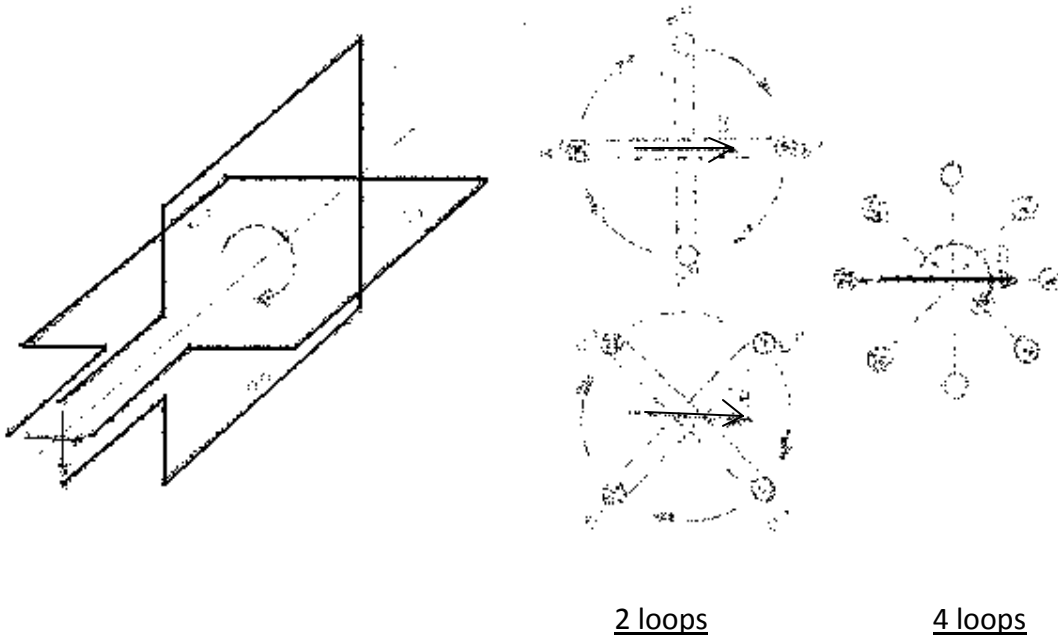

### -1.7 Magnetic circuit

The magnetic field may be obtained by means of permanent magnets (PM), or, more commonly, by means of electromagnets (field coils with iron cores).

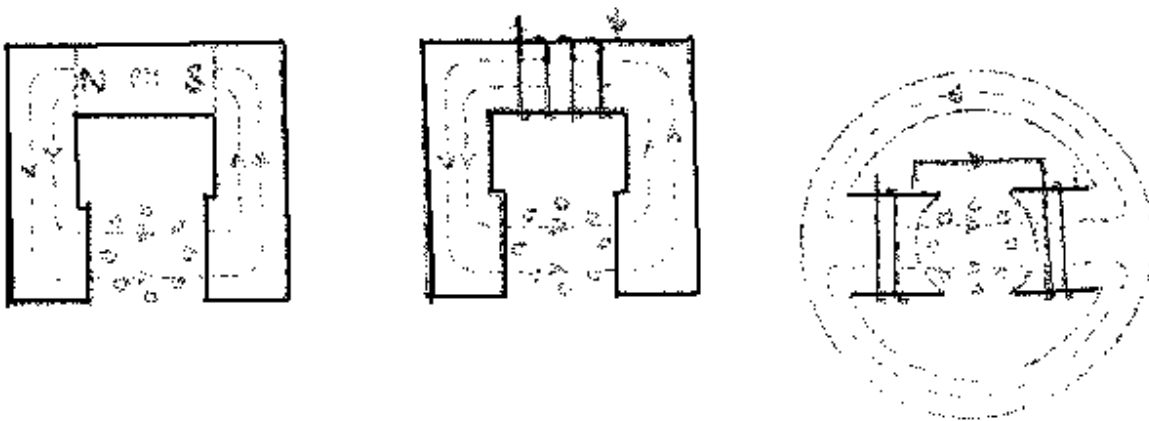

Permanent magnet

electromagnet

practical construction

(with soft iron extension)

The value of the resulting flux is determined by the mmf (magnetic motive force) ( of the PM or electromagnet) and the magnetic reluctance in the path of the flux. Iron has very high magnetic permeability, so that it is the air gap in the path of the flux that limits its value. The air gap must therefore be made short to increase the effective flux. The air gap cannot be avoided completely(why?) .

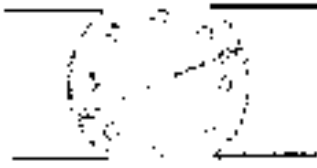

Air core



cylindrical iron core



slotted iron core (armature)

### -1.8 Multiple poles

A dc machine can have 2,4,6,8,..... Poles (an even number-why?)

$2p$  = number of poles; (i.e.  $p$  = number of pole pairs)

One revolution = 360 mechanical degrees;

One pole pair = 360 electrical degrees;

Electrical angle =  $p \times$  mechanical angle;

Pole pitch =  $180^\circ$  electrical =  $360^\circ$  mech /  $2p$ .

Each armature loop is placed over one pole pitch. Electrically, every thing repeats after two pole pitches.

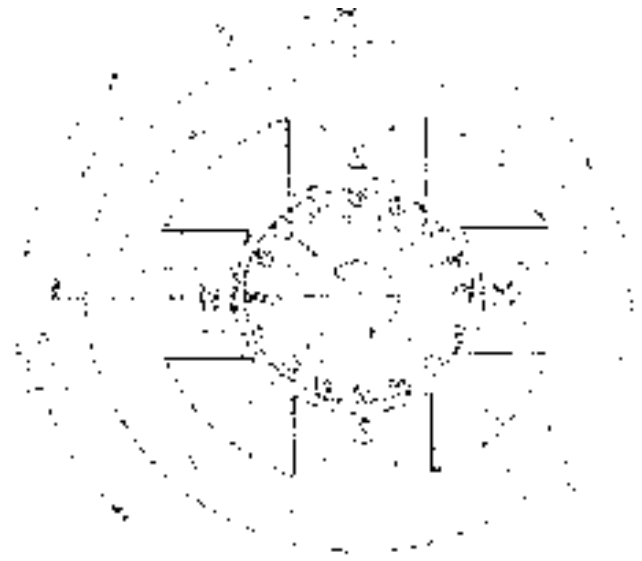

### -1.9 loop emf

$D$  = diameter of the armature [m];

$L$  = active length of armature [m];

$n$  = rotational speed [rps = revolution per second];

$u$  = speed =  $\pi D n$  [m/s];

$\omega_r$  = angular speed =  $2\pi n$  [rad/s].

$A_p$  = armature surface area corresponding to one pole pitch =  $\pi D L / 2p$  [ $m^2$ ].

$\phi$  = flux per pole [wb = weber]; total magnetic flux through pole face: same for all poles;

$B$  = air gap flux density [T = tesla = wb /  $m^2$ ]; normal field at armature surface;



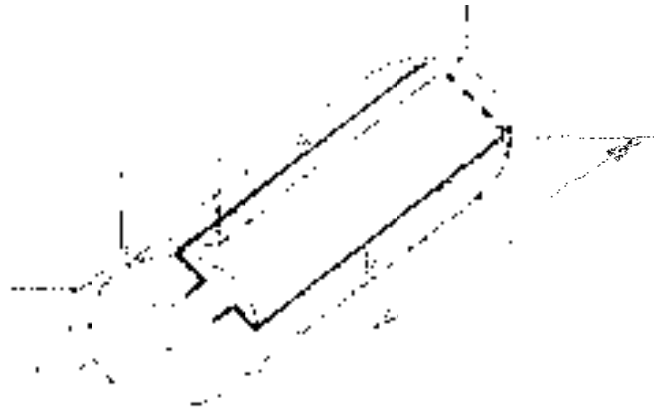

$B_{av}$  = average air gap flux density [T].

$$\Phi = \int_{A_p} B \cdot dA \quad ; \quad B_{av} = \Phi / A_p$$

The actual air gap flux density  $B$  is distributed around the periphery of the armature as shown below. The average gap flux density  $B_{av}$  is constant over a pole pitch. Consider side "a" of the wire loop; the instantaneous emf is

$$e_a = B \cdot L \cdot u \quad (e_a(t) \text{ has the same waveshape as } B)$$

The average emf induced in side "a" is

$$E_a = B_{av} \cdot L \cdot u \quad (\text{constant over alternate pole pitches})$$

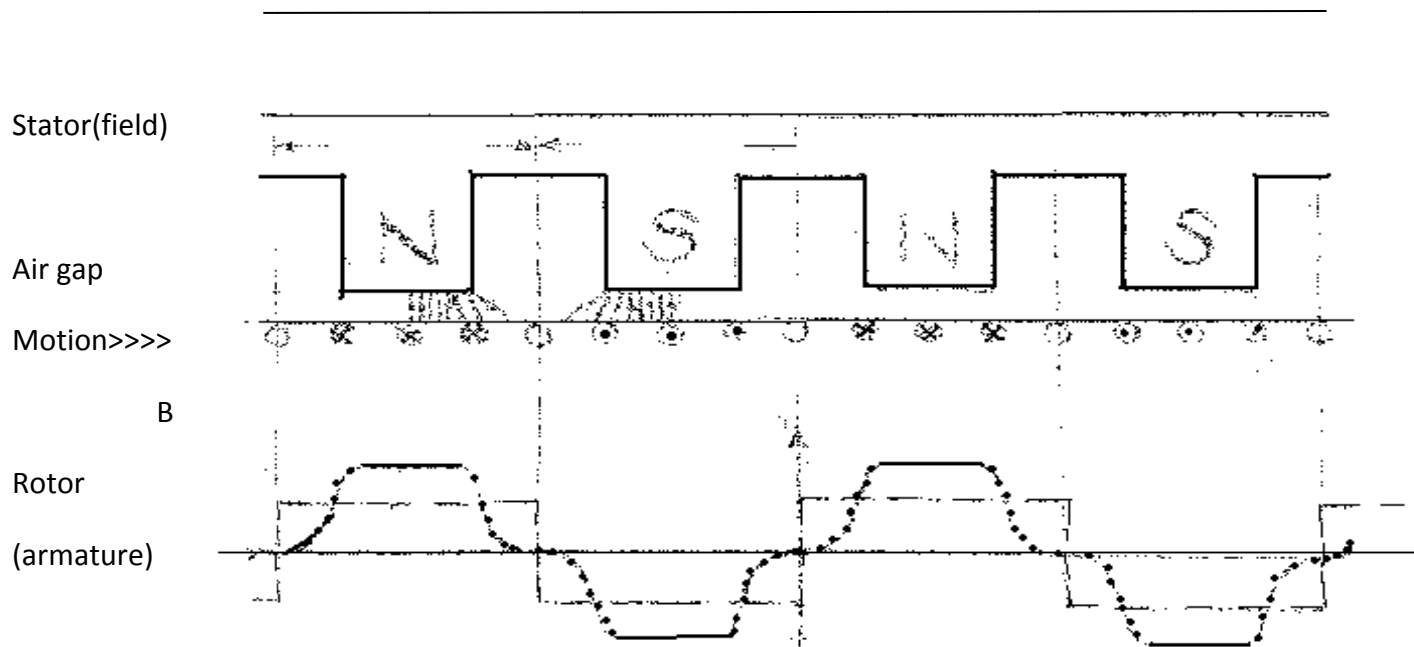

**Average commutated emf**

Wire loop :  $E_{loop} = E_a + E_b = 2 B_{av} \cdot L \cdot u = 2 \pi \cdot D \cdot L \cdot n \cdot B_{av} = (2 \pi \cdot D \cdot L \cdot n)(\phi/A_p)$   
 $= 4p \cdot n \cdot \phi = (2P \cdot \omega_r \cdot \phi) / \pi$  ( $= \Delta\phi/\Delta t = 2 \phi / (1/2pn)$ )

Conductor (one side of loop):

$$E_{con} = 1/2 \cdot E_{loop} = B_{av} \cdot L \cdot u = \pi \cdot D \cdot L \cdot n \cdot B_{av} = 2p \cdot n \cdot \phi = (P \cdot \omega_r \cdot \phi) / \pi$$

Coil (N=number of turns=number of loops in series):

$$E_{coil} = N \times E_{loop} = 2 N \cdot B_{av} \cdot L \cdot u = 2 \pi \cdot D \cdot L \cdot N \cdot n \cdot B_{av} = 4p \cdot N \cdot n \cdot \phi = (2P \cdot N \cdot \omega_r \cdot \phi) / \pi$$
 ( $= N\Delta\phi/\Delta t$ )

**-1.10 loop torque**

The instantaneous force on side "a" is

$$f_a = B \cdot I_a \cdot L$$

The normal field B varies over a pole pitch, and hence  $f_a$  also varies. The average force on side "a" is

$$F_a = B_{av} \cdot I_a \cdot L$$

$B_{av}$ , and hence  $F_a$ , are constant over a pole pitch corresponding to a given pole. Moreover, because of commutation,  $I_a$  reverses over the next pole pitch so that  $F_a$  remains in the same sense around the axis of the armature. The resultant force due to all armature conductors is zero, but there is developed torque because all forces act in the same sense around the axis.

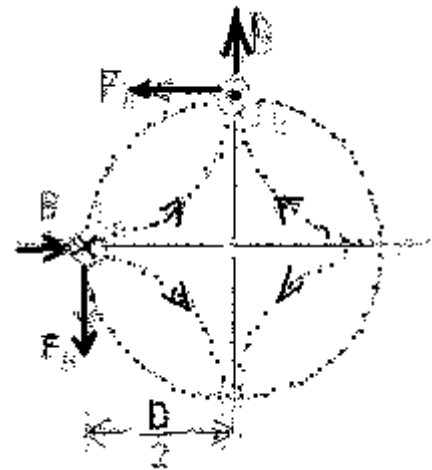
**Average developed torque**

Wire loop  $T_{loop} = F_a \cdot D/2 + F_b \cdot D/2 = D/2(B_{av} \cdot I_a \cdot L + B_{av} \cdot I_b \cdot L) = D \cdot L \cdot I \cdot B_{av}$  [Nm]

Where  $I_a = I_b$ ,  $\gggg$   $T_{loop} = D \cdot L \cdot I (\phi/A_p) = 2p \cdot I \cdot \phi / \pi$

Coil ( N turns):  $T_{coil} = N \times T_{loop} = D.L.N.I. B_{av} = 2p.N.I. \phi / \pi$

For constant rotational speed  $n$ , and assuming no friction, the developed torque is equal to the applied mechanical torque.

### -1.11 Conversion power

A dc machine may run as a generator or as a motor. In each of the two modes of operation, there is induced emf and developed torque ( given by the equations of section 1.9 and 1.10). What determines the mode (generator or motor) is the directional relationship between  $E$ , and  $I$ , and between  $T_d$  and  $n$ :

Generator mode:  $I$  with  $E$ ,  $T_d$  opposite  $n$  ;

Motor mode :  $I$  opposite  $E$ ,  $T_d$  with  $n$ .

Recall the coil equations of section 1.9 and 1.10 ;  $E = E_{coil}$  and  $T_d = T_{coil}$ , we can write

$$E.I = (4p.N.n.\phi). I = 4p.N.\omega_r. \phi.I / 2\pi = (2p.N.I. \phi / \pi) .\omega_r = T_d. \omega_r$$

This represents electromechanical energy conversion. The conversion power is defined as

$$P_c = E.I = T_d. \omega_r \quad \{ E.I \text{ on the electrical side} \text{-----} T_d. \omega_r \text{ on the mechanical side}$$

### Generator action

$R$ =resistance of the coil

$T_m$ =mechanical drive torque

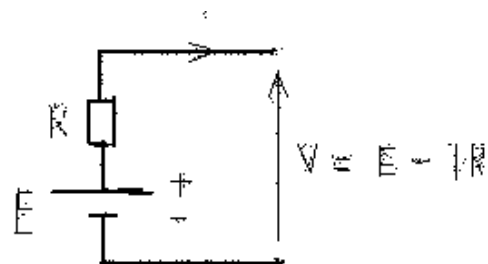

Mech i/p:  $P_{in} = \omega_r. T_d = P_c$

Elect o/p:  $P_{out} = V.I = (E - I.R).I = E.I - I^2.R = P_c - P_{cu}$

$$\gggg P_{out} = P_{in} - P_{cu}$$

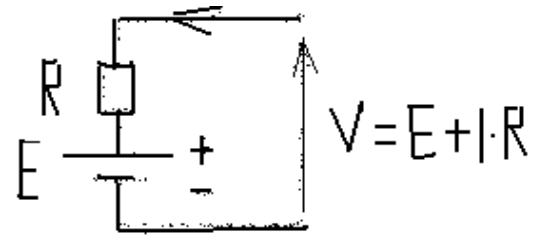
Motor action

Elect i/p:  $P_{in} = V.I = (E + I.R).I = E.I + I^2.R = P_c + P_{cu}$

Mech o/p:  $P_{out} = \omega_r.T_d = P_c$

$$\ggggg P_{out} = P_{in} - P_{cu}$$

More generally,  $P_{out} = P_{in} - \text{losses}$

Where the losses include( in addition to copper losses) mechanical losses(friction and windage), and iron losses(hysteresis and eddy current).

Example 1:

Given that the air gap field is distributed sinusoidally with a maximum flux density of  $B_m$ . Show that  $\phi = B_m.D.L/p$  and  $B_{av} = 2.B_m/\pi$

$$\text{Solution: } B_{av} = 1/\pi \int_0^\pi B_m \cdot \sin\theta \, d\theta = \frac{B_m}{\pi} [-\cos\theta]_0^\pi = \frac{2B_m}{\pi}$$

$$\phi = B_{av} \cdot A_p = \frac{2B_m}{\pi} \cdot \frac{\pi.D.L}{2p} = \frac{B_m.D.L}{p}$$

Tutorial 1:

Given that the air gap field is distributed as shown in fig. 1 over a pole pitch  $y_p$ . Show that

$$\phi = \frac{\alpha\pi}{2} B_m \cdot D.L/p \quad \text{and} \quad B_{av} = \alpha.B_m \quad \text{where} \quad \alpha = \frac{y_a}{y_p}$$

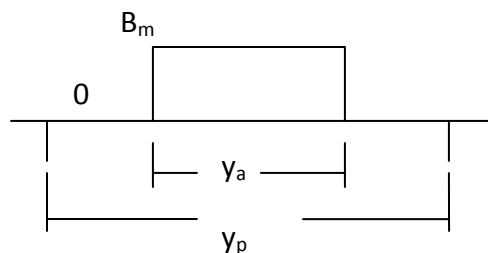

Fig. 1

**Example 2:**

The armature of a dc machine is 80 cm long and has a diameter of 50 cm. The maximum air gap flux density is 1.5 T. The pole arc covers 70% of the pole pitch. The armature speed is 500 rpm.

- (a) If the machine has 2 poles, find the flux per pole and the average air gap flux density when the field distribution is (i) sinusoidal, (ii) as in fig.1 of T.1.  
 (b) Repeat part a for a six pole machine.

For all cases of parts a and b, find the average emf, developed torque, and conversion power for a full pitch wire loop on the armature & carrying 9 A. current.

**Solution:**

-a(i) Sinusoidal field distribution

$$B_{av} = \frac{2B_m}{\pi} = \frac{2 \times 1.5}{\pi} = 0.955 \text{ T}$$

$$\phi = B_{av} \cdot A_p = 0.955 \times \frac{\pi \times 0.5 \times 0.8}{2} = 0.6 \text{ Wb.}$$

$$E_{loop} = 4p.n.\phi = 4 \times 1 \times \frac{500}{60} = 20 \text{ Volts}$$

$$T_{loop} = \frac{2p}{\pi} \cdot I \cdot \phi = 2 \times 9 \times 0.6 / \pi = 3.437 \text{ N.m}$$

$$P_c = \omega_r \cdot T_{loop} = 2\pi \times \frac{500}{60} \times 3.437 = 180 \text{ Watts}$$

-a(ii) field distribution as in fig.1

$$B_{av} = \alpha \cdot B_m = \frac{y_a}{y_p} \cdot B_m = 0.7 \times 1.5 = 1.05 \text{ T}$$

$$\phi = \frac{\alpha\pi}{2} \cdot B_m \cdot D \cdot L / p = 0.66 \text{ Wb.}$$

$$E_{loop} = 4.p.n. \phi = 22 \text{ Volts}$$

$$T_{loop} = \frac{2p}{\pi} \cdot I \cdot \phi = 3.78 \text{ N.m}$$

$$P_c = \omega_r \cdot T_{loop} = 198 \text{ Watts}$$

-b(i) when 2p=6

$$\phi = 0.2 \text{ Wb.}$$

$$E_{\text{loop}}=20 \text{ Volts}$$

$$T_{\text{loop}}=3.437 \text{ N.m}$$

$$P_c= 180 \text{ Watts}$$

-b(ii)

$$\phi= 0.22 \text{ Wb.}$$

$$E_{\text{loop}}=22 \text{ Volts}$$

$$T_{\text{loop}}=3.78 \text{ N.m}$$

$$P_c= 198 \text{ Watts}$$

### **Tutorial 2:**

The armature of a 4-pole dc machine is rotating at 840 rpm. The armature length and diameter are 40 cm and 30 cm respectively. The flux per pole is 65 mWb. For a 5-turn full-pitched armature coil:

- a. Find the average emf induced in the coil.
- b. What current must flow through the coil if it is to develop a torque of 8.0 N.m? what is the resulting conversion power?

Answer(36.4 V, 7.25 A.; 264 W.)

## CHAPTER 2 : **construction**

Electrical machines are essentially electrical and magnetic circuits coupled to each other to develop emf's and torques. Actual machines can vary greatly in details.

### 2.1 **Materials**

a. Iron : high magnetic permeability >> minimize reluctance of magnetic circuit>> high working fields.

High grade steel (e.g. silicon steels) for magnetic cores. Lower grade steels(e.g. cast iron , cast steel, mild steel) for constructional parts. Relative permeability of the linear part of the magnetization (B-H) curve is of the order of 1000, and is higher for higher grade steels.

Saturation limits maximum flux density in iron to 2 T or less; the resulting average gap flux density is then around 0.8 T for practical industrial machines.

b. copper: high electric conductivity>>> minimize resistance of electric circuits>> high working currents. Aluminum is seldom used because of space limitations; (why is silver not used either as long as its resistivity is the lowest?)

c. Air: air gap in path of flux necessary to allow motion.

d. Insulating materials: they are necessary to insulate conductors from each other and from adjacent iron parts (which are also conducting).

The economic factor: machines are generally designed to yield the required performance at minimum cost.

Cost: cost of materials + cost of manufacture.

Required performance: described in terms of operating voltage, current, power, torque, speed, efficiency, weight, volume, reliability, temperature rise, function, noise, pollution, etc.

## 2.2 Losses

Power losses in dc machines include : copper losses ( $I^2.R$  losses in conductors); iron losses (hysteresis & eddy currents); friction and windage. All losses are undesirable because they represent wasted power, and cause the temperature to rise.

Materials retain their desired properties( electrical, magnetic, and mechanical) within specific temperature limits. Temperature rise is most critical to insulating materials: their insulation capability deteriorates at sufficiently high temperatures( around 100 ° C, depending on the particular insulator), and ultimately breaks down causing short circuits and possibly total machine failure. To limit temperature rise, the machine design must minimize losses, and provide for efficient operation.

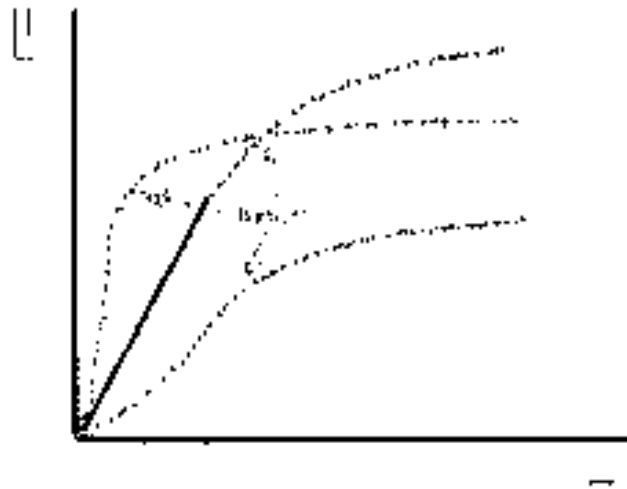

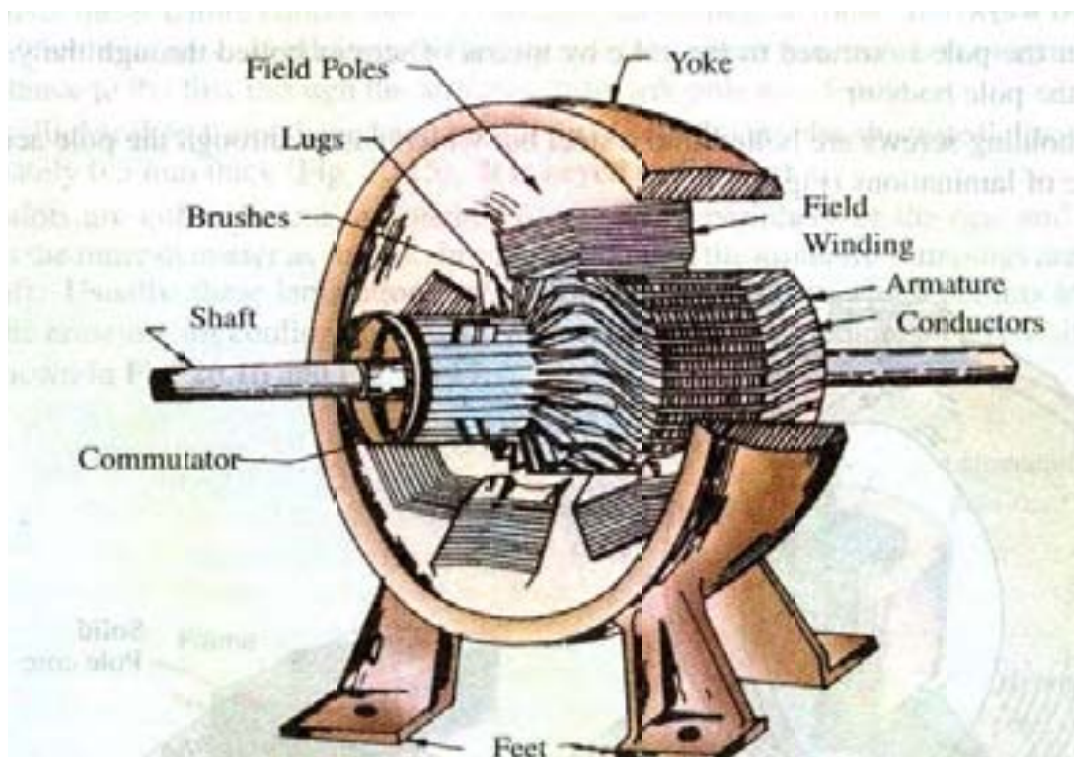

Actual DC Machine

- |                                    |                              |
|------------------------------------|------------------------------|
| 1. Magnetic Frame or Yoke          | 2. Pole-Cores and Pole-Shoes |
| 3. Pole Coils or Field Coils       | 4. Armature Core             |
| 5. Armature Windings or Conductors | 6. Commutator                |
| 7. Brushes and Bearings            |                              |

In general, heat is generated through the volume of the conductor or iron core, but can be dissipated only through its surface. To improve cooling of such parts, their surfaces must be made larger, which means that machines become bigger.

Changing magnetic fields induce emf's not only in copper conductors (which is desirable), but also in iron parts. As iron has a relatively small resistivity, currents will circulate in it. These 'eddy currents' distort the field distribution and, more important, yield  $I^2R$  losses in the iron. To limit these losses, and the resulting temperature rise, some cores are made of steel laminations (instead of solid steel); these are punched sheets (or stampings) around 0.5-1.0 mm thick with insulated facets (paper or suitable coating) stacked and bolted together. The laminations are stacked in the direction of the induced emf so that the insulated surfaces will be in the way of circulating currents.

$$\text{Stacking factor} = \frac{\text{useful length}}{\text{total length}} \cong 0.9-0.97$$



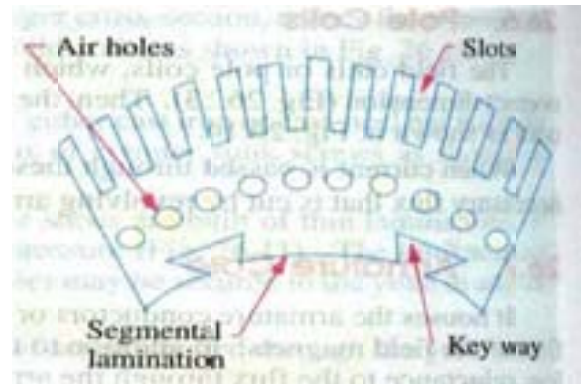
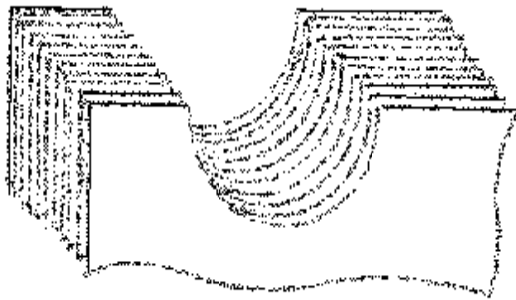

MAIN PARTS OF A DC MACHINE (see figure on page previous page)

### 2.3 **Stator** (field)

**Yoke** : lower grade steel; supports poles; return path for flux; encloses machine.

**Poles**: core and shoes ; high grade steel. Pole core may or may not be laminated. Pole shoes are usually laminated (flux fluctuation due to rotating armature slots). Pole shoes (i) reduce reluctance of the air gap (by increasing its area); (ii) improve flux density distribution in the air gap; and (iii) provide mechanical support for the field coils.

**Field coils**: provide the mmf for the main working flux. There may be more than one set of coils. i.e. 2 or more coils on each pole. The coils of one set are identical to each other, and are connected together electrically.

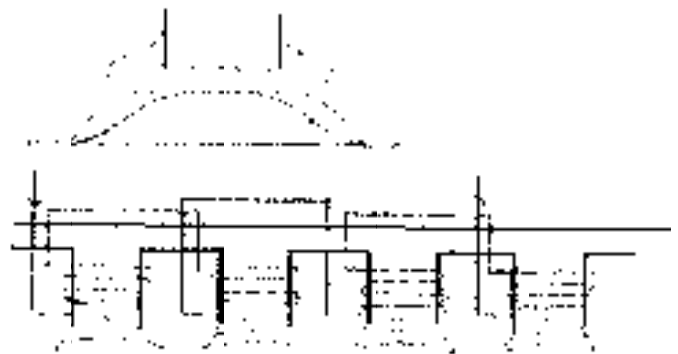
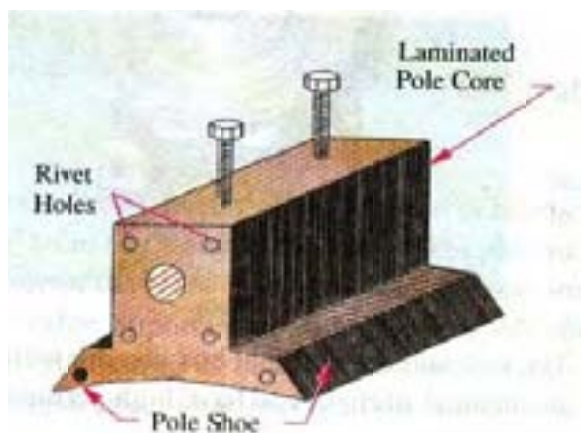

### 2.4 **Rotor** (armature)

The armature is made of high-grade steel laminations punched and stacked together to form a cylinder or drum. It is mounted on the shaft (directly for small machines, and by means of a spider for larger machines). It may have radial and axial ventilation ducts for

Cooling. The armature windings are placed in slots around the armature periphery. The conductors are held in place by wedges, or by bands wrapped around the armature. The slots are sometimes skewed to reduce noise.

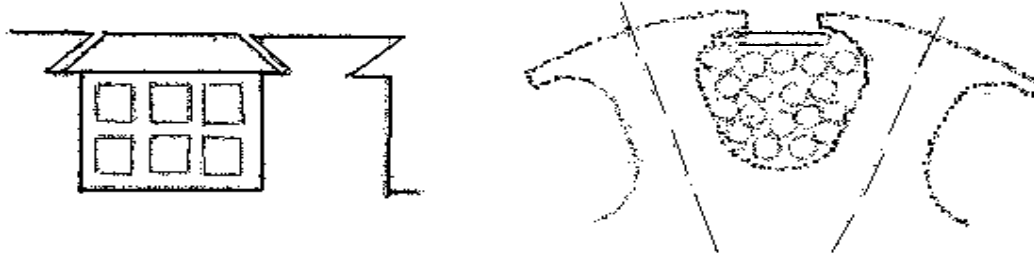

### 2.5 Air gap

The air gap is the space between stator and rotor needed to allow relative motion between them (i.e it is mechanically necessary). Magnetically, it introduces a high reluctance in the path of the working flux (most of the field mmf is consumed in the air gap); it is therefore made as short as possible, typically 0.5-5.0 mm. The armature surface and the pole shoes facing it require precise machining to avoid asymmetry and vibration.

### 2.6 Commutator

The function of the commutator is to interface between the alternating currents and emf's in the rotating armature coils on the one side, and the direct current and voltage at the machine terminals. It is made up of copper segments insulated from each other and mounted on the shaft (i.e it rotates with the rotor) in a cylindrical form. V-rings hold the bars in place. The leads of each armature coil are connected to risers (each of the two leads of a coil goes to a different commutator segment).

Brushes are carbon or graphite blocks mounted in stationary holders with spring pressure to maintain good electrical contact with the rotating commutator segments. The brushes wear out with time and must be replaced regularly.

The commutator is a critical part of the machine: from brushes, carbon fillings and dirt accumulate causing current leakage between segments. Intermittent contact between brushes and segments often leads to sparking, which may become quite serious.

### 2.7 Mechanical items

Shaft; spider; bearings (with grease pack or lubrication system).

Bolts; clamps, spacers, brackets.

Enclosure (frame); ventilation windows, lifting eye; base .

Terminal box; shaft mounted fan; brush gear; etc.

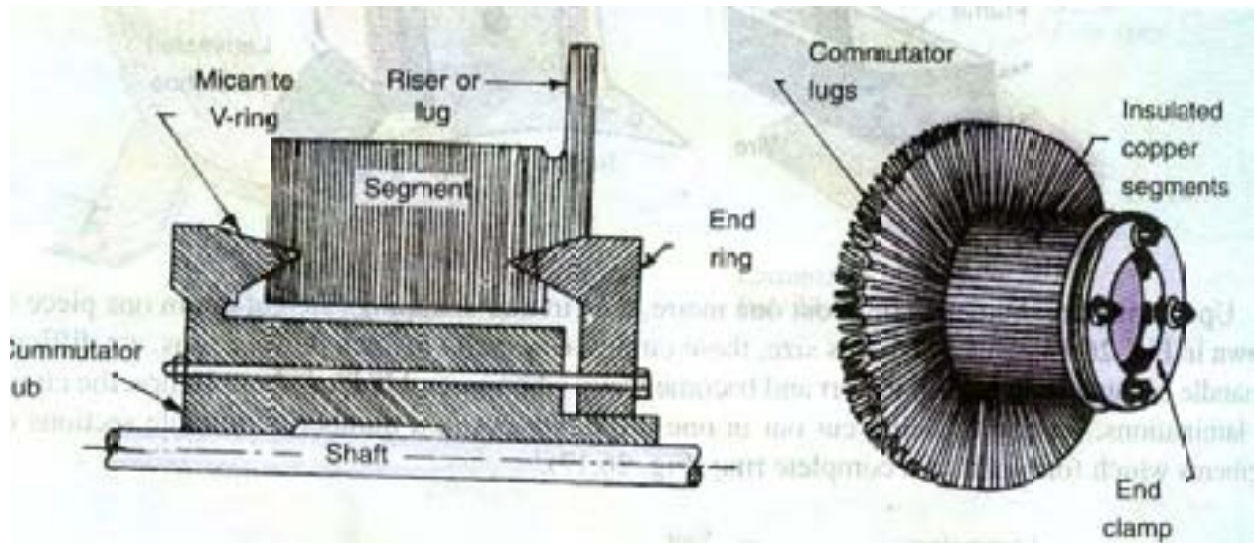

### 2.8 Small (miniature) machines

Very small dc motors are often made with PM fields. The 2-pole machine shown has an annular magnet that may be cross-magnetized as shown , or it may be radially magnetized.

The magnet fits within a steel housing which provides the yoke. The steel blocks in the 4-pole machine shown may be replaced by PM's (at extra cost). For such miniature machines, the armature may have three slots ( and three teeth) as shown, or it may have five slots and teeth . The current-excited field shown may be replaced by a PM. Note carefully the connection of the three armature coils to the three segment commutator; also note the location of the brushes.

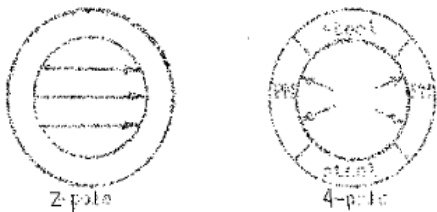

---

## 2.9 **Machine ratings**

The 'name plate' of a machine serves to identify the machine.

It gives rated voltage, current, power, speed, and possibly other data useful to the user. The machine ratings are the values of the various parameters for which the machine will run continuously without overheating or other damage. In practice, the ratings can be exceeded for short periods. If, however, the ratings are exceeded for considerable periods of time, there may be permanent damage, particularly to insulation.

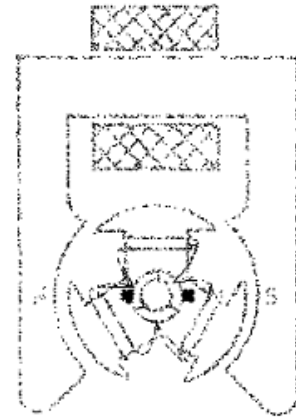

Machines are usually manufactured in standard frame sizes. They also come in different enclosures to suit various environmental conditions and duties (e.g. drip-proof, splash-proof, and submersible).

All materials are subject to physical limitations, i.e. limits beyond which they no longer retain their desired physical characteristics. Proper design and use of machines (and indeed all apparatus) should ensure that none of the constituent materials exceeds its physical limitations under normal operating conditions.

To select an appropriate machine for his system, the user must know clearly the requirements of that application (e.g. speed, voltage, power, etc.) and the conditions under which the machine will be running. He will then be able to select the most economical machine that meets these requirements and conditions.

## Chapter 3: **Armature windings**

The coils on the armature are connected to each other and to the commutator segments to form what is called an 'armature winding'.

### 3.1 **Coil details**

**Coil sides**: active parts of coil; placed inside slots.

**Coil span**: separation between the two coil sides along the armature surface (i.e. the arc covered by the coil).

**Full-pitched coil**: coil span exactly equal to pole pitch.

**Chorded or short-pitched coil**: coil span slightly less (or possibly more) than an exact pole pitch.

All sections of the coil are insulated : from each other, from adjacent coils, and from core iron. The level of insulation at any point is determined by the potential difference being insulated.

Coils designed for low voltage and high current have few turns of large sections; conversely , coils for high voltage and low current have many turns of small sections. Large machines have few turns/coil, possibly only one, made of preformed copper bars. Small machines' coils are made of many turns of flexible wire wound and bent to shape.

### 3.2 Two-layer windings

Machine winding are made in two layers: for each coil, one coil side is placed in the top half of its slot(top layer), and the second coil side is placed in the bottom half of its slot( bottom layer). This makes it easy to arrange end connections (front & back) in a regular manner; all coils are then identical so that the winding is symmetrical and compact. There are at least two coil sides in each slot, one in the top layer and one in bottom layer. In large machines, there may be 2,3,4, etc. coil sides per slot.

For example , if we have 3 coil sides/slot/layer and 2 turns/coil then:

Number of conductors/slot/layer=  $3 \times 2 = 6$

Conductors/slot=  $2 \times 6 = 12$  ( also, we can say 6 coilsides/slot)

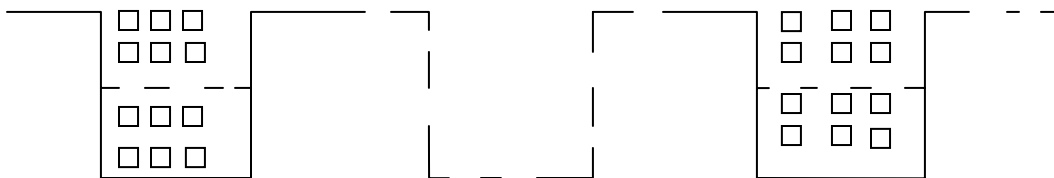

### 3.3 Some numbers

$C$  = total number of coils on armature;     $N$  = number of turns in each coil;

$NC$  = total number of loops;     $Z$  = total number of armature conductors =  $2NC$

$2C = Z/N$  = total number of coil sides;     $S$  = total number of slots in armature;

$Z/S = 2NC/S$  = number of conductors/slot;     $2C/S$  = number of coil sides/slot;

$NC/S$  = number of conductors/slot/layer;     $C/S$  = number of coil sides/slot/layer;

$S/2P$  = number of slots/pole = pole pitch measured in slots.

### 3.4 Interconnection of coils

All the coils on the armature are connected together to form a single closed circuit (called the armature winding): starting with any coil, its end is connected to the beginning of a second coil; the end of the second coil is connected to the beginning of a third coil, and so on. This is repeated until the last coil, Cth coil, is reached; its end is connected to the beginning of the first coil, so that the circuit is closed. The interconnections between the coils are made on the commutator: the second lead of the 1<sup>st</sup> coil and the first lead of the 2<sup>nd</sup> coil are soldered together on the riser of one commutator segment; the second lead of the 2<sup>nd</sup> coil and the first lead of the 3<sup>rd</sup> coil are soldered together on the riser of another commutator segment; finally, the second lead of the last (Cth) coil and the first lead of the 1<sup>st</sup> coil are soldered to the riser of one commutator segment.

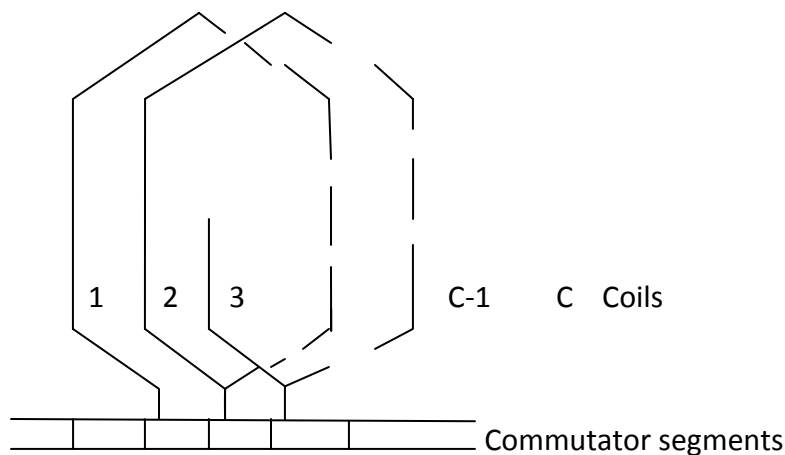

A full line indicates a coil side lying in the top layer, and a dashed line indicates a coil side lying in the bottom layer. Arrows on coil sides may be taken to indicate direction of either induced emf or current.

It should be remembered that

Total number of commutator segments= total number of coils=C

### 3.5 Winding schemes

Armature coils may be interconnected according to one of two schemes, giving rise to two types of armature windings, lap and wave.

$y_c$  = commutator pitch = number of commutator segments advanced from the first coil lead to the second ( same for all coils).



Lap winding

wave winding

**3.5.1 Lap Winding**

In lap windings, the two coil ends are connected to adjacent commutator segments; i.e. if the lead from side a is connected to commutator segment x, then the lead from side b is connected to segment x±1. Thus

$$y_c = \pm 1$$

The winding is continued until all coils are traversed up to the last coil C, which then closes on the first coil. A lap winding can be made to fit any number of coils and poles, C and 2p. The choice of progressive or retrogressive windings has no significant effect.

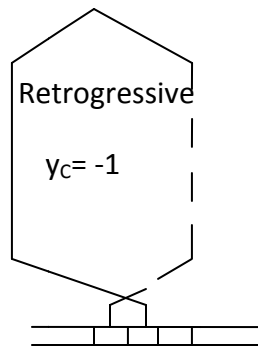
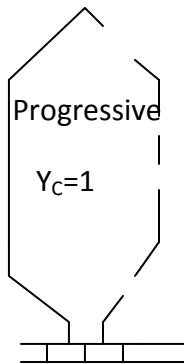

**3.5.2 Wave winding**

In wave windings, the two coil ends are connected to commutator segments that are approximately two pole pitches apart (where a pole pitch is now measured in number of segments or coils, i.e. C/2p). The commutator pitch is then

$$y_c = (C \pm 1)/P \gggg C = p \cdot y_c \pm 1$$

After traversing all pole pairs, the winding should return to a commutator segment adjacent to the initial one, either the one just after it (progressive), or the one just before it (retrogressive).

The winding is continued until all coils are traversed with the last coil closing on the first coil. Unlike the lap winding, the wave winding cannot be made to fit just any number of coils and poles: in the above equation, the values of  $C$  and  $p$  must be such that  $y_c$  turns out to be an integer. ( If a wave winding is to be placed on an unsuitable armature, some coil positions must be left out; for mechanical balance, dummy coils are placed in these positions ( dummy coils are not connected electrically).

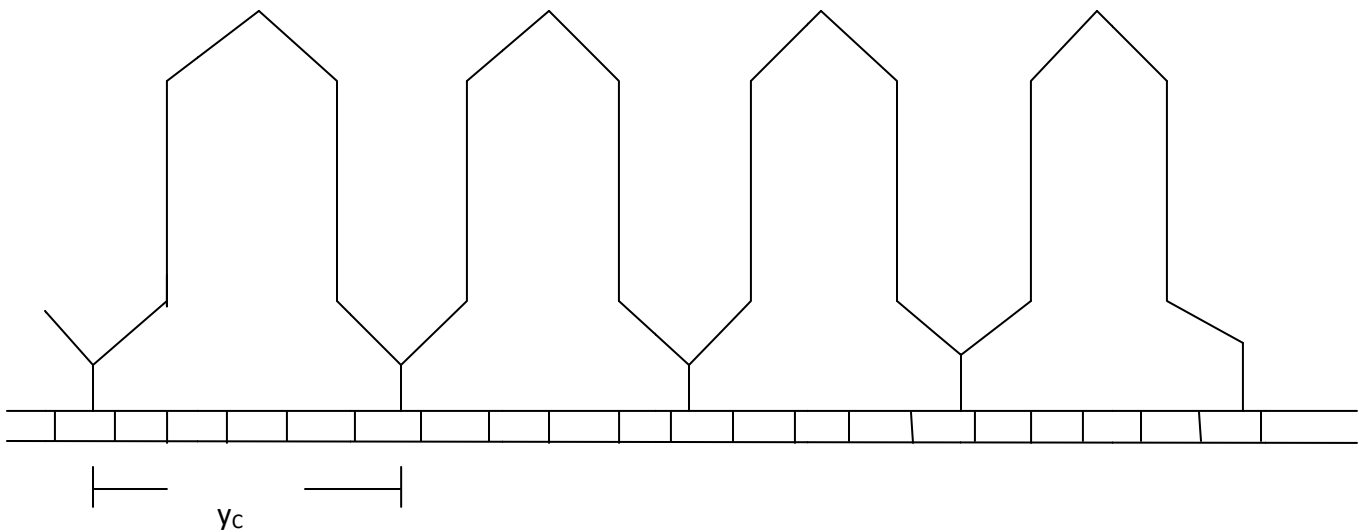

Two types of windings mostly employed for drum-type armatures are known as Lap Winding and Wave Winding. The difference between the two is merely due to the different arrangement of the end connections at the front or commutator end of armature. Each winding can be arranged progressively or retrogressively and connected in simplex, duplex and triplex. The following rules, however, apply to both types of the windings :

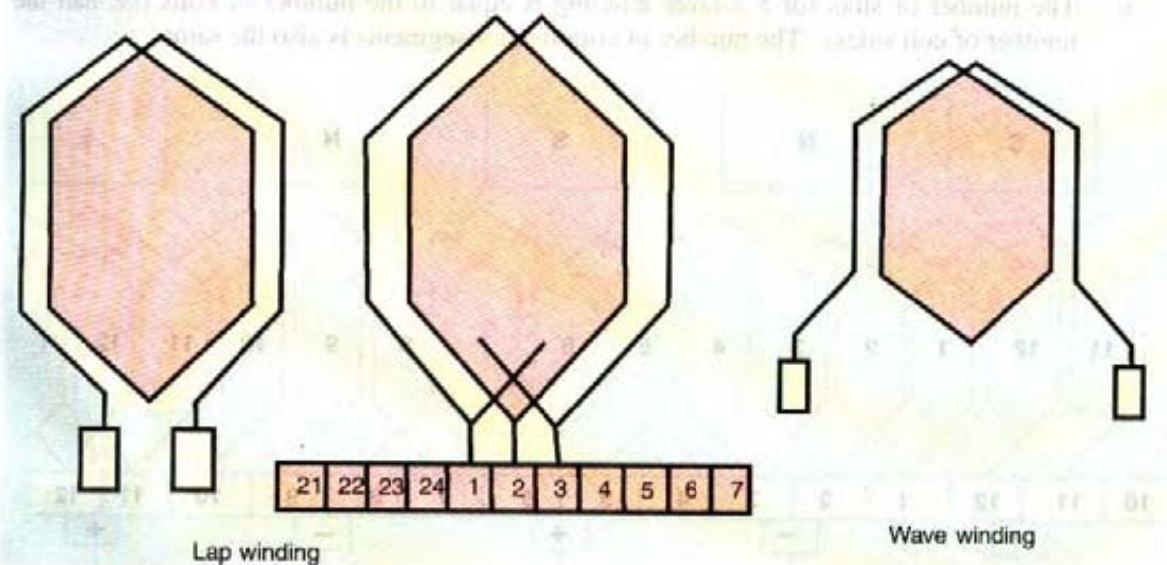



- (i) The front pitch and back pitch are each approximately equal to the pole-pitch *i.e.* windings should be full-pitched. This results in increased e.m.f. round the coils. For special purposes, fractional-pitched windings are deliberately used
- (ii) Both pitches should be odd, otherwise it would be difficult to place the coils (which are former-wound) properly on the armature. For example, if  $Y_B$  and  $Y_F$  were both even, the *all* the coil sides and conductors would lie either in the upper half of the slots or in the lower half. Hence, it would become impossible for one side of the coil to lie in the upper half. Hence, it would become impossible for one side of the coil to lie in the upper half of one slot and the other side of the same coil to lie in the lower half of some other slot.
- (iii) The number of commutator segments is equal to the number of slots or coils (or half the number of conductors) because the front ends of conductors are joined to the segments in pairs.
- (iv) The winding must close upon itself *i.e.* if we start from a given point and move from one coil to another, then all conductors should be traversed and we should reach the same point again without a break or discontinuity in between.

### Simplex Lap-winding\*

It is shown in Fig. 26.25 which employs single-turn coils. In lap winding, the finishing end of one coil is connected to a commutator segment and to the starting end of the adjacent coil situated under the same pole and so on, till all the coils have been connected. This type of winding derives its name from the fact it doubles or laps back with its succeeding coils.

Following points regarding simplex lap winding should be carefully noted :

1. The back and front pitches are odd and of opposite sign. But they cannot be equal. They differ by 2 or some multiple thereof.
2. Both  $Y_B$  and  $Y_F$  should be nearly equal to a pole pitch.
3. The average pitch  $Y_A = \frac{Y_B + Y_F}{2}$ . It equals pole pitch =  $\frac{Z}{P}$ .
4. Commutator pitch  $Y_C = \pm 1$ . (In general,  $Y_C = \pm m$ )
5. Resultant pitch  $Y_R$  is even, being the arithmetical difference of two odd numbers, *i.e.*,  $Y_R = Y_B - Y_F$ .
6. The number of slots for a 2-layer winding is equal to the number of coils (*i.e.* half the number of coil sides). The number of commutator segments is also the same.

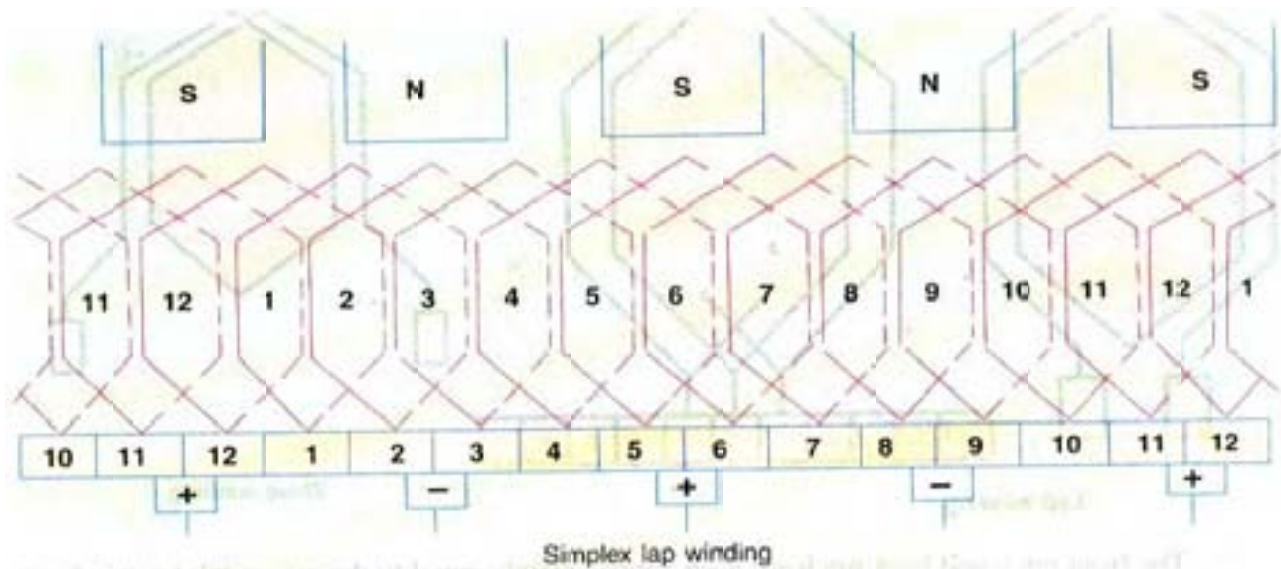

- \* However, where heavy currents are necessary, duplex or triplex lap windings are used. The duplex lap winding is obtained by placing two similar windings on the same armature and connecting the even-numbered commutator bars to one winding and the odd-numbered ones to the second winding. Similarly, in triplex lap winding, there would be three windings, each connected to one third of the commutator bars.

7. The number of parallel paths in the armature =  $mP$  where  $m$  is the multiplicity of the winding and  $P$  the number of poles.

Taking the first condition, we have  $Y_B = Y_F \pm 2$ .

(a) If  $Y_B > Y_F$  i.e.  $Y_B = Y_F + 2$ , then we get a progressive or right-handed winding i.e. a winding which progresses in the clockwise direction as seen from the commutator end. In this case, obviously,  $Y_C = +1$ .

(b) If  $Y_B < Y_F$  i.e.  $Y_B = Y_F - 2$ , then we get a retrogressive or left-handed winding i.e. one which advances in the anti-clockwise direction when seen from the commutator side. In this case,  $Y_C = -1$ .

(c) Hence, it is obvious that

$$\left. \begin{aligned} Y_F &= \frac{Z}{P} - 1 \\ Y_B &= \frac{Z}{P} + 1 \end{aligned} \right\} \text{for progressive winding and} \quad \left. \begin{aligned} Y_F &= \frac{Z}{P} + 1 \\ Y_B &= \frac{Z}{P} - 1 \end{aligned} \right\} \text{for retrogressive winding}$$

Obviously,  $Z/P$  must be even to make the winding possible.

### Numbering of Coils and Commutator Segments

In the d.c. winding diagrams to follow, we will number the coils only (not individual turns). The upper side of the coil will be shown by a firm continuous line whereas the lower side will be shown by a broken line. The numbering of coil sides will be consecutive i.e. 1, 2, 3 ..... etc. and such that odd numbers are assigned to the top conductors and even numbers to the lower sides for a two-layer winding. The commutator segments will also be numbered consecutively, the number of the segments will be the same as that of the upper side connected to it.

**Example 26.1.** Draw a developed diagram of a simple 2-layer lap-winding for a 4-pole generator with 16 coils. Hence, point out the characteristics of a lap-winding.

(Elect. Engineering, Madras Univ. 1981)

**Solution.** The number of commutator segments = 16

Number of conductors or coil sides  $16 \times 2 = 32$ ; pole pitch =  $32/4 = 8$

Now remembering that (i)  $Y_B$  and  $Y_F$  have to be odd and (ii) have to differ by 2, we get for a progressive winding  $Y_B = 9$ ;  $Y_F = -7$  (retrogressive winding will result if  $Y_B = 7$  and  $Y_F = -9$ ). Obviously, commutator pitch  $Y_C = -1$ .

[Otherwise, as shown in Art. 26.26, for progressive winding

$$Y_F = \frac{Z}{P} - 1 = \frac{32}{4} - 1 = 7 \text{ and } Y_B = \frac{Z}{P} - 1 = \frac{32}{4} + 1 = 9]$$

The simple winding table is given as under :

<i>Back Connections</i>	→	<i>Front Connections</i>
1 to (1 + 9) = 10	→	10 to (10 - 7) = 3
3 to (3 + 9) = 12	→	12 to (12 - 7) = 5
5 to (5 + 9) = 14	→	14 to (14 - 7) = 7
7 to (7 + 9) = 16	→	16 to (16 - 7) = 9
9 to (9 + 9) = 18	→	18 to (18 - 7) = 11
11 to (11 + 9) = 20	→	20 to (20 - 7) = 13
13 to (13 + 9) = 22	→	22 to (22 - 7) = 15
15 to (15 + 9) = 24	→	24 to (24 - 7) = 17
17 to (17 + 9) = 26	→	26 to (26 - 7) = 19
19 to (19 + 9) = 28	→	28 to (28 - 7) = 21

\*\* In general,  $Y_B = Y_F \pm 2m$  where  $m = 1$  for simplex lap winding and  $m = 2$  for duplex lap winding etc.

21 to (21 + 9) = 30	→	30 to (30 - 7) = 23
23 to (23 + 9) = 32	→	32 to (32 - 7) = 25
25 to (25 + 9) = 34 = (34 - 32) = 2	→	2 to (34 - 7) = 27
27 to (27 + 9) = 36 = (36 - 32) = 4	→	4 to (36 - 7) = 29
29 to (29 + 9) = 38 = (38 - 32) = 6	→	6 to (38 - 7) = 31
31 to (31 + 9) = 40 = (40 - 32) = 8	→	8 to (40 - 7) = 33 = (33 - 32) = 1

The winding ends here because we come back to the conductor from where we started.

We will now discuss the developed diagram which is one that is obtained by imagining the armature surface to be removed and then laid out flat so that the slots and conductors can be viewed without the necessity of turning round the armature in order to trace out the armature windings. Such a developed diagram is shown in Fig. 26.31.

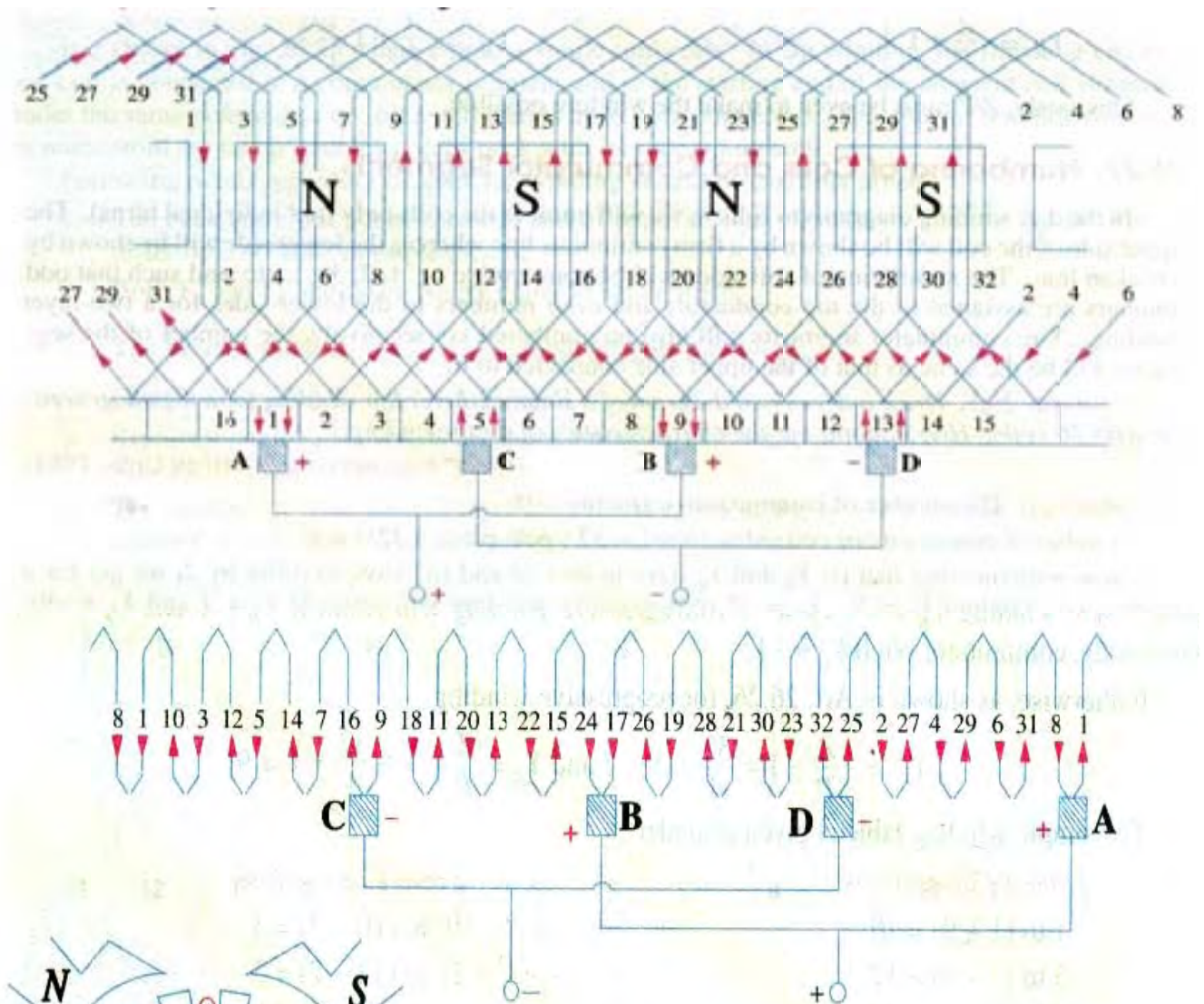

Fig. 26.31

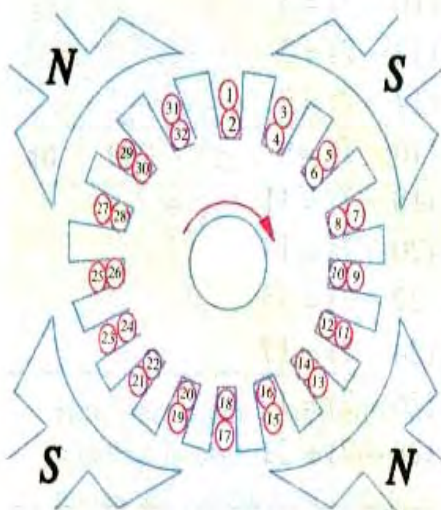

Fig. 26.32

The procedure of developing the winding is this :

Front end of the upper side of coil No. 1 is connected to a commutator segment (whose number is also 1). The back end is joined at the back to the  $1 + 9 = 10$ th coil side in the lower half of 5th slot. The front end of coil side 10 is joined to commutator segment 2 to which is connected the front end of  $10 - 7 = 3$  i.e. 3rd coil side lying in the upper half of second armature slot. In this way, by travelling 9 coil sides to the right at the back and 7 to the left at the

front we complete the winding, thus including every coil side once till we reach the coil side 1 from where we started. Incidentally, it should be noted that all upper coil sides have been given odd numbers, whereas lower ones have been given even numbers as shown in the polar diagram (Fig. 26.32) of the winding of Fig. 26.31.

Brush positions can be located by finding the direction of currents flowing in the various conductors. If currents in the conductors under the influence of a *N*-pole are assumed to flow downwards (as shown), then these will flow upwards in conductors under the influence of *S*-pole. By putting proper arrows on the conductors (shown separately in the equivalent ring diagram), it is found that commutator bars No. 1 and 9 are the meeting points of e.m.f.s. and hence currents are flowing out of these conductors. The positive brushes should, therefore, be placed at these commutator bars. Similarly, commutator bars No. 5 and 13 are the separating points of e.m.f.s. hence negative brushes are placed there. In all, there are four brushes, two positive and two negative. If brushes of the same polarity are connected together, then all the armature conductors are divided into four parallel paths.

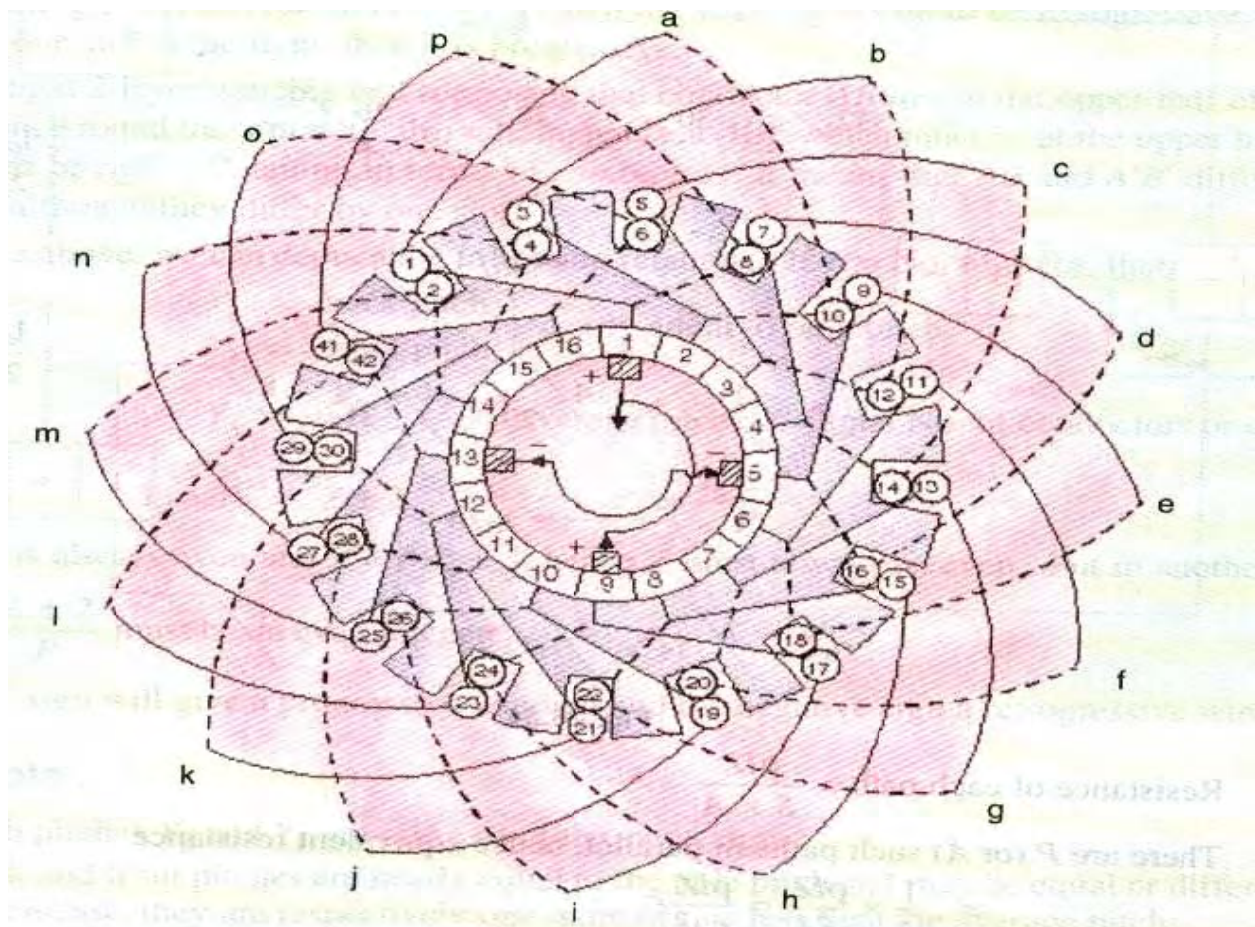

Division of conductors into parallel paths is shown separately in the schematic diagram of Fig. 26.34. Obviously, if  $I_a$  is the total current supplied by the generator, then current carried by each parallel path is  $I_a/4$ .

Summarizing these conclusions, we have

1. The total number of brushes is equal to the number of poles.
2. There are as many parallel paths in the armature as the number of poles. That is why such a winding is sometimes known as 'multiple circuit' or 'parallel' winding. In general, number of parallel paths in armature =  $mP$  where  $m$  is the multiplicity (plex) of the lap winding. For example, a 6-pole duplex lap winding has  $(6 \times 2) = 12$  parallel paths in its armature.
3. The e.m.f. between the +ve and -ve brushes is equal to the e.m.f. generated in any one of the parallel paths. If  $Z$  is the total number of armature conductors and  $P$  the number of poles, then the number of armature conductors (connected in series) in any parallel path is  $Z/P$ .

$$\therefore \text{Generated e.m.f. } E_g = (\text{Average e.m.f./conductor}) \times \frac{Z}{P} = e_{av} \times \frac{Z}{P}$$

4. The total or equivalent armature resistance can be found as follows :

Let  $l$  = length of each armature conductor;  $S$  = its cross-section

$A$  = No. of parallel paths in armature =  $P$  – for simplex lap winding

$R$  = resistance of the whole winding then  $R = \frac{\rho l}{S} \times Z$

$$\text{Resistance of each path} = \frac{\rho l Z}{S \times A}$$

There are  $P$  (or  $A$ ) such paths in parallel, hence equivalent resistance

$$= \frac{1}{A} \times \frac{\rho l Z}{SA} = \frac{\rho l Z}{SA^2}$$

5. If  $I_a$  is the total armature current, then current per parallel path (or carried by each conductor) is  $I_a/P$ .

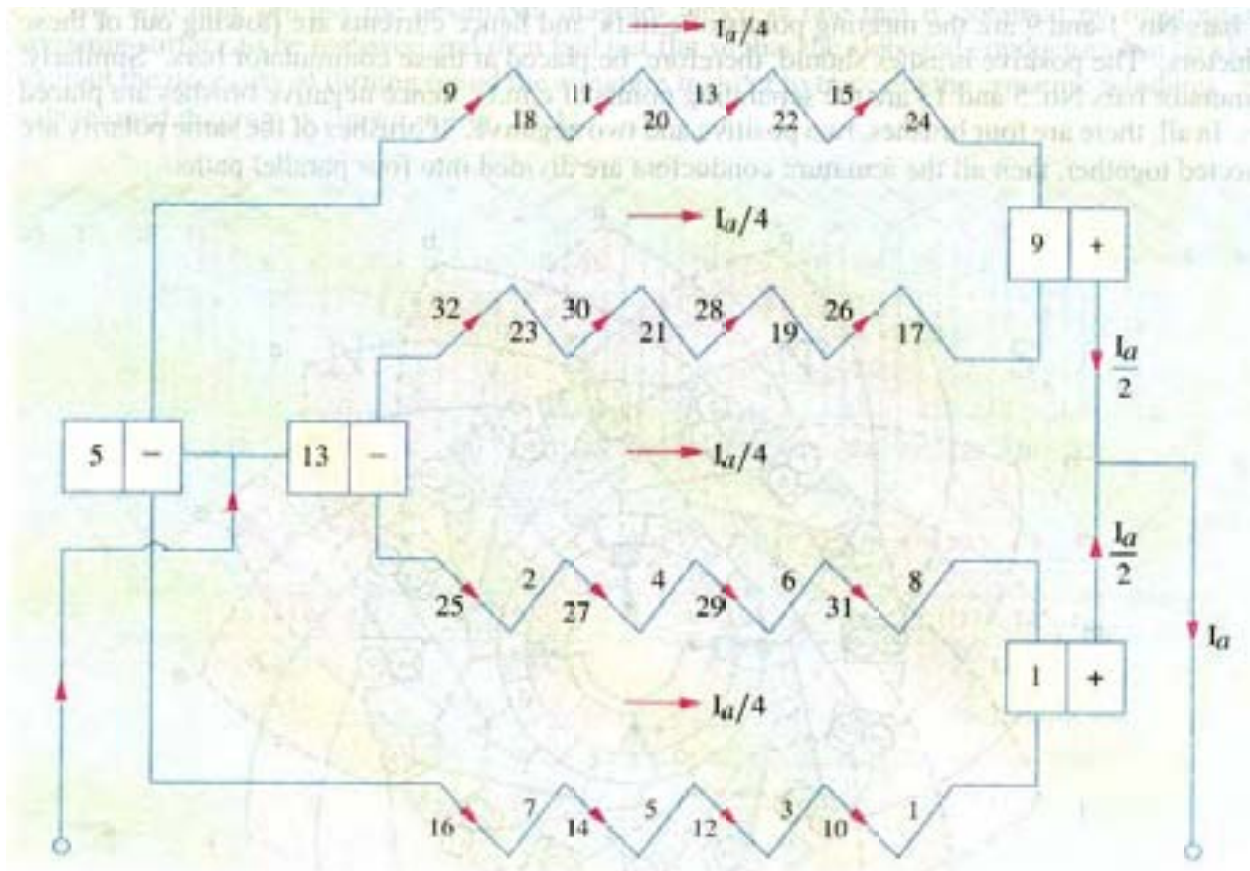

### Simplex Wave Winding\*

From Fig. 26.31, it is clear that in lap winding, a conductor (or coil side) under one pole is connected at the back to a conductor which occupies an almost corresponding position under the *next* pole of *opposite* polarity (as conductors 3 and 12). Conductor No. 12 is then connected to conductor No. 5 under the *original* pole but which is a little removed from the initial conductor No. 3. If, instead of returning to the same *N*-pole, the conductor No. 12 were taken *forward* to the next *N*-pole, it would make no difference so far as the direction and magnitude of the e.m.f. induced in the circuit are concerned.

- Like lap winding, a wave winding may be duplex, triplex or may have any degree of multiplicity. A simplex wave winding has two paths, a duplex wave winding four paths and a triplex one six paths etc.

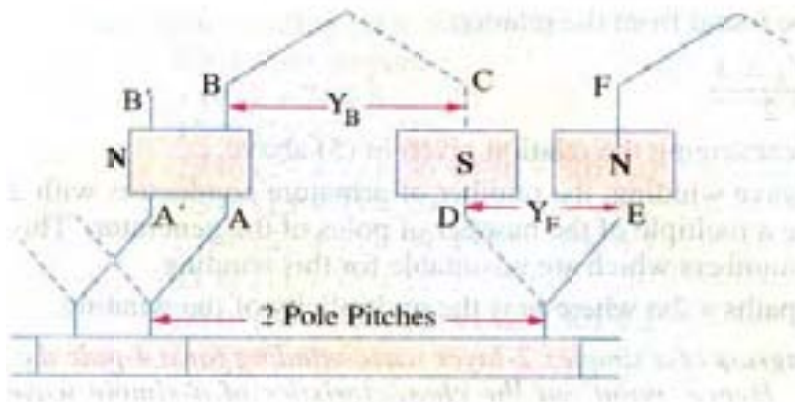

Fig. 26.35

As shown in Fig. 26.35, conductor  $AB$  is connected to  $CD$  lying under  $S$ -pole and then to  $EF$  under the next  $N$ -pole. In this way, the winding progresses, passing successively under every  $N$ -pole and  $S$ -pole till it returns to a conductor  $A'B'$  lying under the original pole. Because the winding progresses in one direction round the armature in a series of 'waves', it is known as wave winding.

If, after passing once round the armature, the winding falls in a slot to the

left of its starting point (as  $A'B'$  in Fig. 26.35) then the winding is said to be retrogressive. If, however, it falls one slot to the right, then it is progressive.

Assuming a 2-layer winding and supposing that conductor  $AB$  lies in the upper half of the slot, then going once round the armature, the winding ends at  $A'B'$  which must be at the upper half of the slot at the left or right. Counting in terms of *conductors*, it means that  $AB$  and  $A'B'$  differ by two conductors (although they differ by one slot).

From the above, we can deduce the following relations. If  $P = \text{No. of poles}$ , then

$$\left. \begin{array}{l} Y_B = \text{back pitch} \\ Y_F = \text{front pitch} \end{array} \right\} \text{nearly equal to pole pitch}$$

then 
$$Y_A = \frac{Y_B + Y_F}{2} = \text{average pitch}; Z = \text{total No. of conductors or coil sides}$$

$$\text{Then, } Y_A \times P = Z \pm 2 \quad Y_A = \frac{Z \pm 2}{P}$$

Since  $P$  is always even and  $Z = PY_A \pm 2$ , hence  $Z$  must always be even. Put in another way, it means that  $\frac{Z \pm 2}{P}$  must be an even integer.

The plus sign will give a progressive winding and the negative sign a retrogressive winding.



**Points to Note :**

1. Both pitches  $Y_B$  and  $Y_F$  are odd and of the same sign.
  2. Back and front pitches are nearly equal to the pole pitch and may be equal or differ by 2, in which case, they are respectively one more or one less than the average pitch.
  3. Resultant pitch  $Y_R = Y_F + Y_B$ .
  4. Commutator pitch,  $Y_C = Y_A$  (in lap winding  $Y_C = \pm 1$ ).
- Also,
- $$Y_C = \frac{\text{No. of Commutator bars} \pm 1}{\text{No. of pair of poles}}$$
5. The average pitch which must be an integer is given by

$$Y_A = \frac{Z \pm 2}{P} = \frac{\frac{Z}{2} \pm 1}{P/2} = \frac{\text{No. of Commutator bars} \pm 1}{\text{No. of pair of poles}}$$

It is clear that for  $Y_A$  to be an integer, there is a restriction on the value of  $Z$ . With  $Z = 32$ , this winding is impossible for a 4-pole machine (though lap winding is possible). Values of  $Z = 30$  or  $34$  would be perfectly alright.

6. The number of coils i.e.  $N_C$  can be found from the relation.

$$N_C = \frac{PY_A \pm 2}{2}$$

This relation has been found by rearranging the relation given in (5) above.

7. It is obvious from (5) that for a wave winding, the number of armature conductors with 2 either added or subtracted must be a multiple of the number of poles of the generator. This restriction eliminates many even numbers which are unsuitable for this winding.
8. The number of armature parallel paths =  $2m$  where  $m$  is the multiplicity of the winding.

**Example 26.2.** Draw a developed diagram of a simplex 2-layer wave-winding for a 4-pole d.c. generator with 30 armature conductors. Hence, point out the characteristics of a simple wave winding. (Elect. Engg-I, Nagpur Univ. 1991)

**Solution.** Here,  $Y_A = \frac{30 \pm 2}{4} = 8^*$  or 7. Taking  $Y_A = 7$ , we have  $Y_B = Y_F = 7$

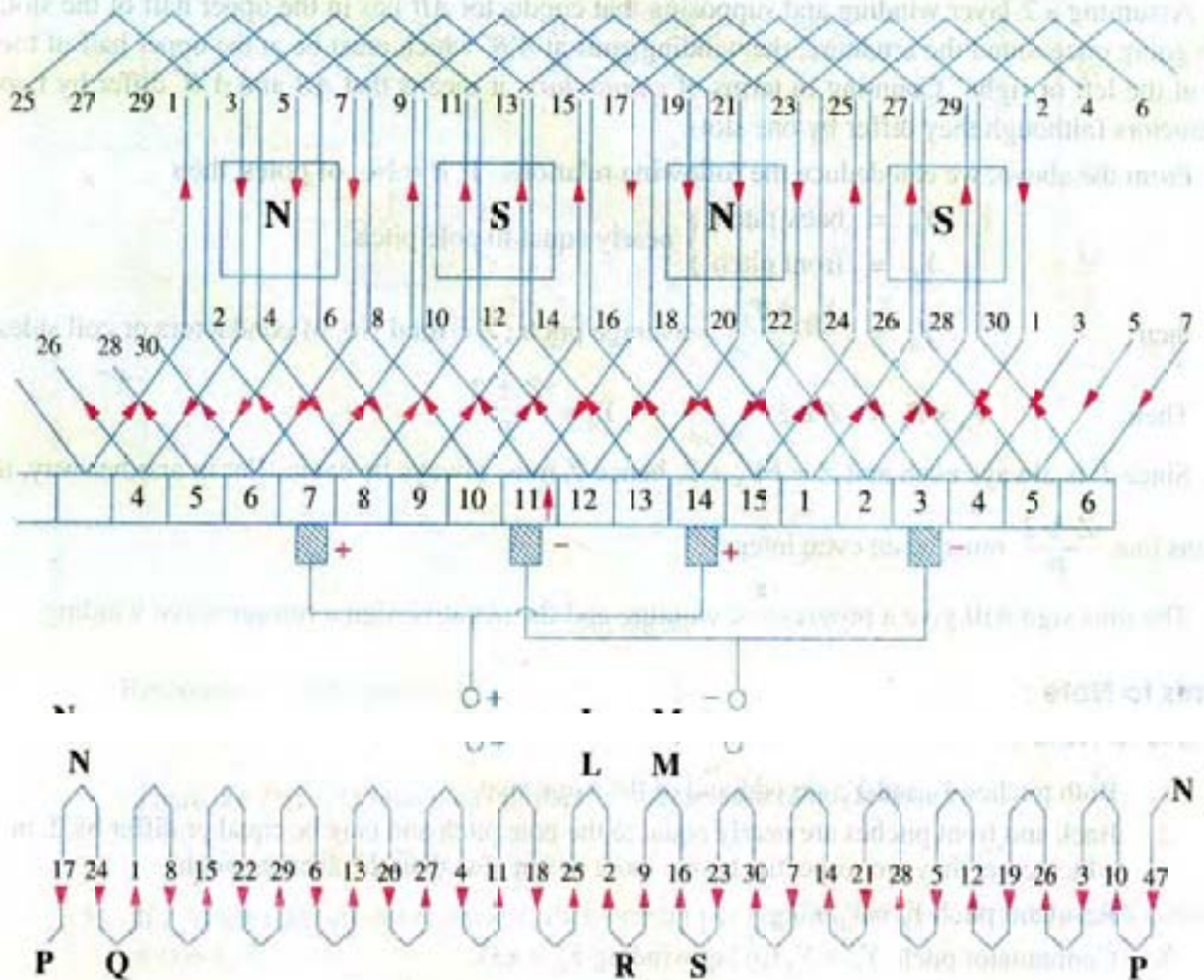

Fig. 26.36

As shown in Fig. 26.36 and 26.37, conductor No. 5 is taken to conductor No.  $5 + 7 = 12$  at the back and is joined to commutator segment 5 at the front. Next, the conductor No. 12 is joined to commutator segment  $5 + 7 = 12$  ( $\because Y_C = 7$ ) to which is joined conductor No.  $12 + 7 = 19$ . Continuing this way, we come back to conductor No. 5 from where we started. Hence, the winding closes upon itself.

\* If we take 8, then the pitches would be :  $Y_B = 9$  and  $Y_F = 7$  or  $Y_B = 7$  and  $Y_F = 9$ . Incidentally, if  $Y_A = Y_C$  is taken as 7, armature will rotate in one direction and if  $Y_C = 8$ , it will rotate in the opposite direction.

The simple winding table is as under :

**Back Connections**

1 to $(1 + 7) = 8$	→
15 to $(15 + 7) = 22$	→
29 to $(29 + 7) = 36 = (36 - 30) = 6$	→
13 to $(13 + 7) = 20$	→
27 to $(27 + 7) = 34 = (34 - 30) = 4$	→
11 to $(11 + 7) = 18$	→
25 to $(25 + 7) = 32 = (32 - 30) = 2$	→
9 to $(9 + 7) = 16$	→
23 to $(23 + 7) = 30$	→
7 to $(7 + 7) = 14$	→
21 to $(21 + 7) = 28$	→
5 to $(5 + 7) = 12$	→
19 to $(19 + 7) = 26$	→
3 to $(3 + 7) = 10$	→
17 to $(17 + 7) = 24$	→

**Front Connections**

8 to $(8 + 7) = 15$
22 to $(22 + 7) = 29$
6 to $(6 + 7) = 13$
20 to $(20 + 7) = 27$
4 to $(4 + 7) = 11$
18 to $(18 + 7) = 25$
2 to $(2 + 7) = 9$
16 to $(16 + 7) = 23$
30 to $(30 + 7) = 37 = (37 - 30) = 7$
14 to $(14 + 7) = 21$
28 to $(28 + 7) = 35 = (35 - 30) = 5$
12 to $(12 + 7) = 19$
26 to $(26 + 7) = 33 = (33 - 30) = 3$
10 to $(10 + 7) = 17$
24 to $(24 + 7) = 31 = (31 - 30) = 1$

Since we come back to the conductor No. 1 from where we started, the winding gets closed at this stage.

### Brush Position

Location of brush position in wave-winding is slightly difficult. In Fig. 26.36 conductors are supposed to be moving from left to right over the poles. By applying Fleming's Right-hand rule, the directions of the induced e.m.fs in various armature conductors can be found. The directions shown in the figure have been found in this manner. In the lower part of Fig. 26.36 is shown the equivalent ring or spiral diagram which is very helpful in understanding the formation of various parallel paths in the armature. It is seen that the winding is electrically divided into two portions. One portion consists of conductors lying between points *N* and *L* and the other of conductors lying between *N* and *M*. In the first portion, the general trend of the induced e.m.fs. is from left to right whereas in the second portion it is from right to left. Hence, in general, there are only two parallel paths through the winding, so that two brushes are required, one positive and one negative.

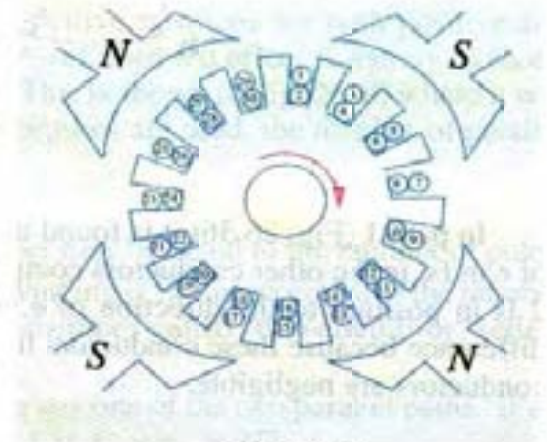
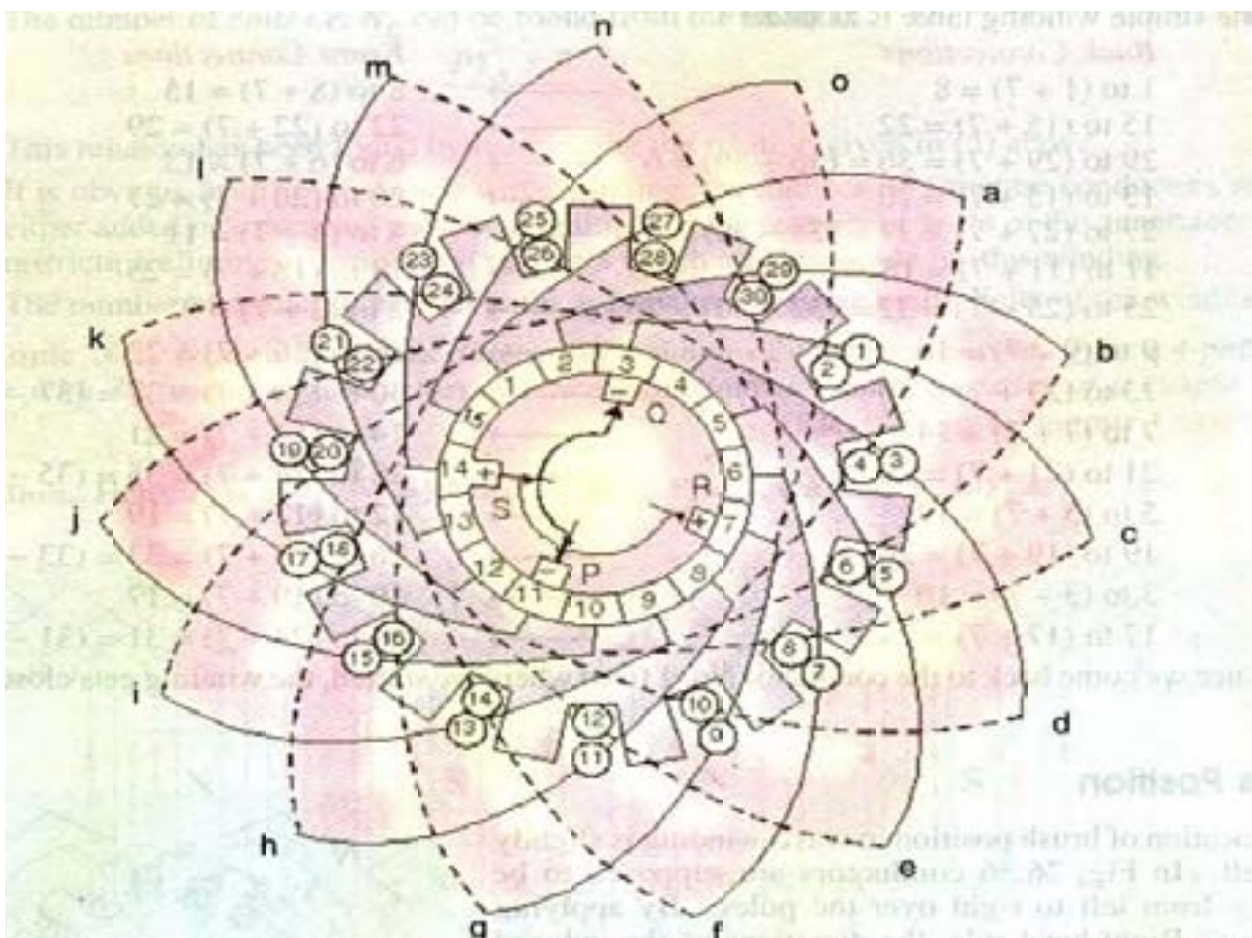

Fig. 26.37

From the equivalent ring diagram, it is seen that point  $N$  is the separating point of the e.m.fs. induced in the two portions of the winding. Hence, this fixes the position of the negative brush. But as it is at the back and not at the commutator end of the armature, the negative brush has two alternative positions *i.e.* either at point  $P$  or  $Q$ . These points on the equivalent diagram correspond to commutator segments No. 3 and 11.

Now, we will find the position of the positive brush. It is found that there are two meeting points of the induced e.m.fs. *i.e.* points  $L$  and  $M$  but both these points are at the back or non-commutator end of the armature. These two points are separated by one loop only, namely, the loop composed of conductors 2 and 9, hence the middle point  $R$  of this loop fixes the position of the positive brush, which should be placed in touch with commutator segment No. 7. We find that for one position of the +ve brush, there are two alternative positions for the -ve brush.

Taking the +ve brush at point  $R$  and negative brush at point  $P$ , the winding is seen to be divided into the following two paths.



In path 1 (Fig. 26.36) it is found that e.m.f. in conductor 9 is in opposition to the general trend of e.m.fs. in the other conductors comprising this path. Similarly, in path 2, the e.m.f. in conductor 2 is in position to the direction of e.m.fs. in the path as a whole. However, this will make no difference because these conductors lie almost in the interpolar gap and, therefore e.m.fs. in these conductors are negligible.

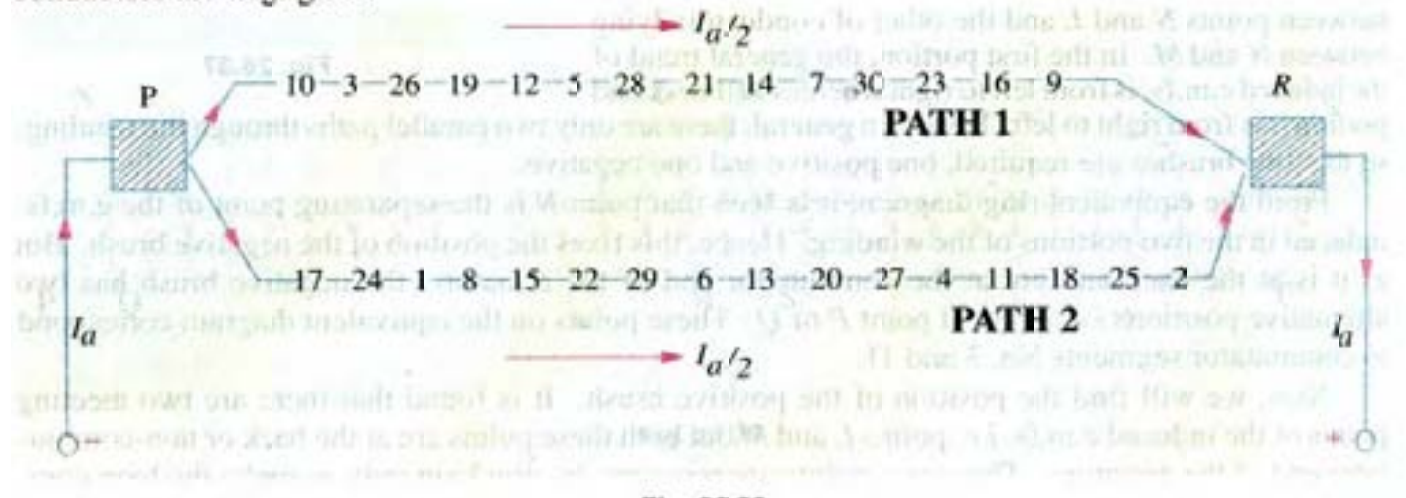

Again, take the case of conductors 2 and 9 situated between points  $L$  and  $M$ . Since the armature conductors are in continuous motion over the pole faces, their positions as shown in the figure are only instantaneous. Keeping in this mind, it is obvious that conductor 2 is about to move from the influence of  $S$ -pole to that of the next  $N$ -pole. Hence, the e.m.f. in it is at the point of reversing. However, conductor 9 has already passed the position of reversal, hence its e.m.f. will not reverse,

rather it will increase in magnitude gradually. It means that in a very short interval, point  $M$  will

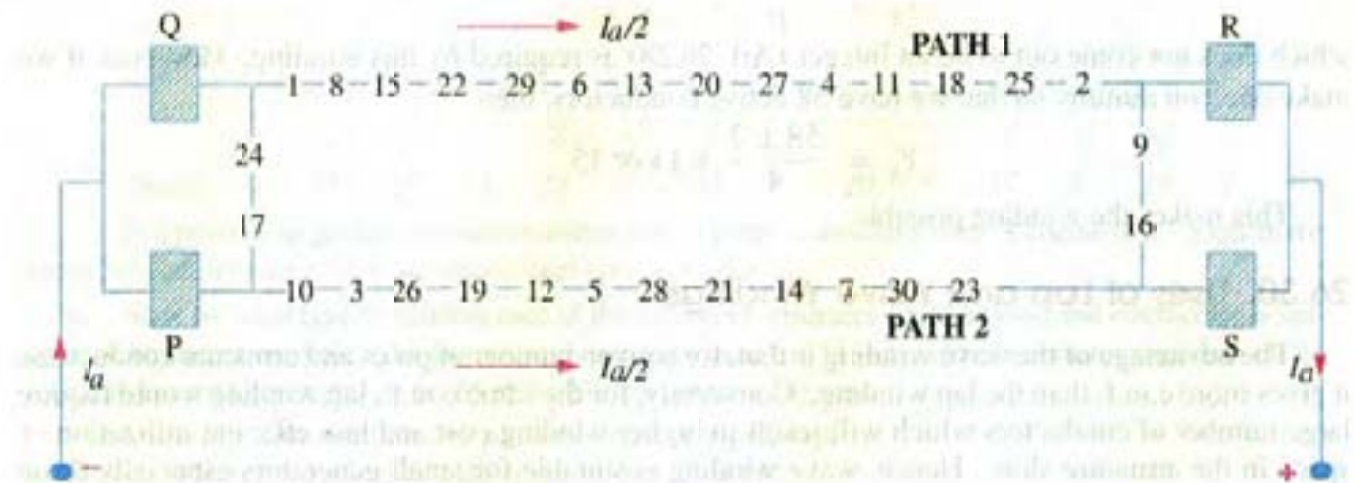

Fig. 26.40

become the meeting point of the e.m.fs. But as it lies at the back of the armature, there are two alternative positions for the +ve brush *i.e.* either point  $R$  which has already been considered or point  $S$  which corresponds to commutator segment 14. This is the second alternative position of the positive brush. Arguing in the same way, it can be shown that after another short interval of time, the alternative position of the positive brush will shift from segment 14 to segment 15. Therefore, if one positive brush is in the contact with segment 7, then the second positive brush if used, should be in touch with both segments 14 and 15.

It may be noted that if brushes are placed in both alternative positions for both positive and negative (*i.e.* if in all, 4 brushes are used, two +ve and two -ve), then the effect is merely to short-circuit the loop lying between brushes of the same polarity. This is shown in Fig. 26.40 where it will also be noted that irrespective of whether only two or four brushes are used, the number of parallel paths through the armature winding is still two.

Summarizing the above facts, we get

1. Only two brushes are necessary, though their number may be equal to the number of poles.
2. The number of parallel paths through the armature winding is two irrespective of the number of generator poles. That is why this winding is sometimes called 'two-circuit' or 'series' winding.
3. The generator e.m.f. is equal to the e.m.f. induced in any one of the two parallel paths. If  $e_{av}$  is the e.m.f. induced/conductor, then generator e.m.f. is  $E_g = e_{av} \times Z/2$ .
4. The equivalent armature resistance is nearly one-fourth of the total resistance of the armature winding.
5. If  $I_a$  is the total armature current, then current carried by each path or conductor is obviously  $I_a/2$  whatever the number of poles.

### 3.6 Parallel paths

From the previous section, it can be seen that the armature coils form a closed winding that is tapped by the brushes at certain points. In effect, the brushes divide the winding into a number of parallel paths each of which is composed of a number of coils in series. The terminal current is divided among the parallel paths. At any moment during operation, there are short-circuited coils; these are not included in the paths. The circuit diagrams for the lap and wave windings are shown below. In each case, the terminal voltage is equal to the voltage of the individual parallel paths.

From the sequence diagram in page 29 for the lap wdg., it can be seen that all the brushes are necessary: if any brush is removed, there will be opposing emf's in series (which would cancel out). Thus the number of brushes is equal to the number of poles, and hence the number of parallel paths is also equal to the number of poles:

Lap wdg:  $2a=2p$ ,  $\gggg$   $a=p$ ,  $2a$ =number of parallel paths;  $a$ =number of pairs of parallel paths

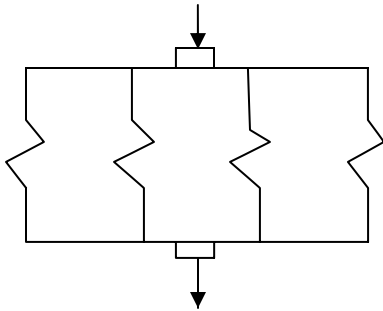

From the sequence diagram in page 36 for the wave wdg, on the other hand, it can be seen that only two brushes are really necessary; alternate brushes are connected to each other internally through short-circuited coils. Thus 2 brushes may be disconnected and removed without affecting induced emf's and currents. In other words, the brushes divide the wdg into two parallel paths only:

Wave wdg:  $2a=2$ ,  $\gggggg$   $a=1$ .

The extra brushes may be removed, but in practice, they are sometimes kept to obtain better current distribution over the commutator.

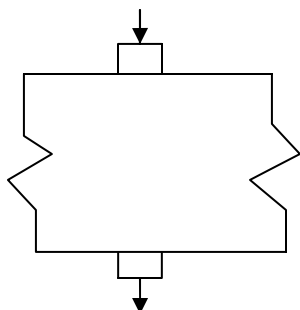

General symbolic representation

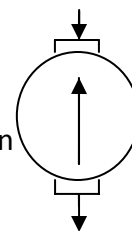

### 3.7 Comparison of lap and wave windings

A lap wdg has  $2p$  parallel paths and must have  $2p$  brushes (or brush groups). A wave wdg has two parallel paths and requires only two brushes (or brush groups), but it can have  $2p$  brushes.

A lap wdg can be made to fit any number of coils and poles. A wave wdg can be fitted only if the number of coils and poles yield an integer commutator pitch  $y_c = (C \pm 1)/p$ .

A brush on a lap wdg generally short-circuits one coil during commutation. In a wave wdg having only two brushes, each brush short-circuits  $p$  coils in series; in a wave wdg having  $2p$  brushes, a coil is short-circuited by two brushes in series.

Assume now that a given wdg can be connected in either lap or wave. The coil emf and current are the same in both cases. The lap-connected wdg will have a high terminal current and a low terminal voltage, while the wave-connected wdg will have a low terminal current and a high terminal voltage (for  $2p \geq 4$ ). The two wdgs will have the same power.

Conversely, assume a machine is to have a specified terminal voltage and a specified terminal current. If it is connected in lap, it will have a low current per coil, and a high voltage per coil; therefore each coil will have many turns of small cross-section, and a higher level of insulation is needed. If it is connected in wave, it will have a high current per coil and a low voltage per coil; therefore the coils will have relatively few turns and large sections, and a relatively lower level of insulation is needed. In this respect, wave wdgs are better than lap wdgs because they allow for better cooling of wdgs, and because they have higher space factors (space factor = copper area/total slot area). In general, wave wdgs are used in almost all machines up to 50 KW, and in all high voltage machines. Lap wdgs are used mostly in large machines having low voltage/high current ratings.

### 3.8 Equalizers

In lap wdgs, each path is associated with a pair of poles. Thus if there is asymmetry in the magnetic circuit (due to wear of bearings, or eccentricity of shaft), the emf's induced in the paths will not all exactly equal to each other. Unequal emf's connected in parallel give rise to circulating currents that can be quite large, causing heavy and unnecessary heating.

To reduce this effect, points that should have the same voltage are connected to each other by means of equalizers (or equalizing connections, or equalizing rings). Such points are located two pole pitches apart. Each equalizing ring is connected to  $p$  points in alternate paths.

In the wave wdg, there are only two paths through the armature. The coils of each path are distributed uniformly around the armature, and hence cover all pole pairs. Any asymmetry in



the magnetic circuit will have the same effect on both paths, so that the two induced emf's will be identical. Thus wave wdgs do not require equalizers, which is another advantage of wave wdgs.

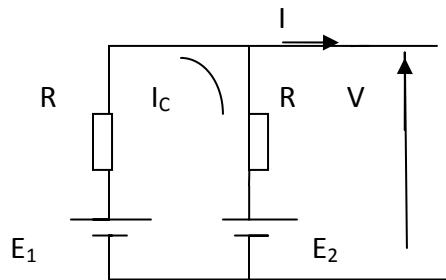

At no load  $I=0$  and  $I_c = \frac{E_1 - E_2}{2R}$

### 3.9 Multiplex windings

The lap and wave wdgs described so far are called simple or simplex wdgs. Duplex wdgs are composed of two simplex wdgs interleaved around the armature, and connected so as to have twice as many parallel paths:

Duplex lap wdg :  $2a=4p$

$$a=2p$$

Duplex wave wdg:  $2a=4$

$$a=2$$

similarly, there may be triplex wdgs, and so on. Such multiplex wdgs are rarely used.

### 3.10 Armature calculations

Consider a symmetrical wdg composed of  $2a$  identical parallel paths. It has

$C/2a$  coils/path,

$C/a$  coil sides/paths,

$Z/2a = NC/a$  conductor/path

Let

$E_p$ =induced emf in each path;

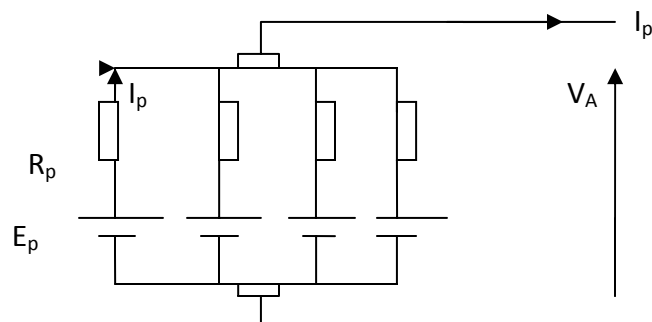

$I_p$ =current flowing through each path;

$R_p$ =resistance of each path.

Also let

$V_A$ =armature terminal voltage;

$I_A$ =armature terminal current;

$E_A$ =armature emf= Thevenin equivalent emf for armature winding;

$R_{pp}$ =Thevenin equivalent resistance for armature winding;

$R_A$ =total effective armature resistance.

Applying KVL:

Generator:  $V_A = E_A - I_A \cdot R_A$

Motor :  $V_A = E_A + I_A \cdot R_A$

### 3.10.1 Armature resistance

Single loop:  $R_{loop} = \frac{\rho l_m}{A}$

Where  $\rho$  = resistivity of copper at the working temperature;

$l_m$ =mean length of a single loop;

$A$ =cross-sectional area of the conductor.

coil  $R_{coil} = N \times R_{loop} = \frac{N \rho l_m}{A}$

Path  $R_p = \frac{C}{2a} \times R_{coil} = \frac{NC \rho l_m}{2aA} = \frac{Z \rho l_m}{4aA}$

Winding:  $R_{pp} = \frac{1}{2a} R_p = \frac{NC \rho l_m}{4a^2 A} = \frac{Z \rho l_m}{8a^2 A}$

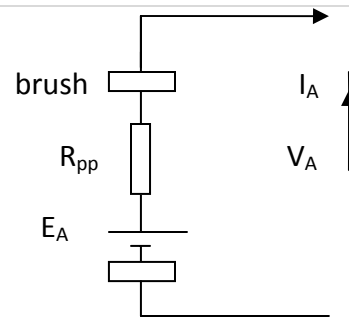

Thevenin equivalent for armature wdg

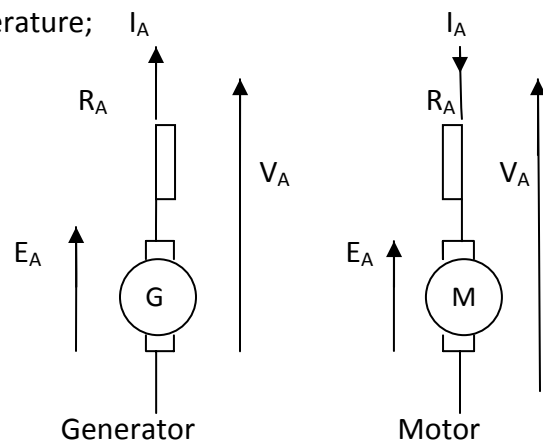

Common symbolic representation of armature winding

Effective armature resistance:  $R_A = R_{pp} + R_{brushes} + R_{contact}$ ;

$R_{brushes}$  is the resistance of the carbon brushes.  $R_{contact}$  is the resistance of the brush/commutator contact surface; it is nonlinear, and is usually taken as equivalent to a constant volt drop (for example 1 volt).

### 3.10.2 Armature emf

The average coil emf derived in section 1.9 is the same for all armature coils. Thus, for each path

$$E_p = \frac{C}{2a} \times E_{\text{coil}} = \frac{2pCN}{a} n \cdot \phi$$

But all paths are in parallel with each other, so that the armature emf is equal to the individual path emf's:

$$E_A = E_p = \frac{C}{2a} \times E_{\text{coil}} = \frac{2pCN}{a} n \cdot \phi = K_e \cdot n \cdot \phi \quad \left( K_e = \frac{2pCN}{a} = \frac{Z_p}{a} \right)$$

An alternative expression can be obtained in terms of  $\omega_r$  ( $=2\pi \cdot n$ ):

$$E_A = \left( K_e / 2\pi \right) \omega_r \cdot \phi = K \cdot \omega_r \cdot \phi \quad \left( K = K_e / 2\pi = \frac{2pCN}{\pi a} = \frac{Z_p}{2\pi a} \right)$$

### 3.10.3 Torque

According to KCL, the terminal current  $I_A$  is the sum of all path currents:

$$I_A = 2a \times I_p \quad \gggggg \quad I_p = I_A / 2a$$

A path is composed of coils in series, so that the path current  $I_p$  flows through the individual coils:

$$I_{\text{coil}} = I_p$$

The average coil torque was derived in section 1.19 :

$$T_{\text{coil}} = \frac{2p}{\pi} N \cdot I_{\text{coil}} \cdot \phi = \frac{2p}{\pi} N \cdot I_p \cdot \phi = \frac{pN}{\pi a} \cdot I_A \cdot \phi$$

The total armature torque is the sum of all coil torques acting in the same direction and aiding each other:

$$T = C \times T_{\text{coil}} = \frac{pCN}{\pi a} \cdot I_A \cdot \phi = K \cdot I_A \cdot \phi \quad \left( K = \frac{pCN}{\pi a} = \frac{Z_p}{2\pi a} \text{ as before} \right)$$

### 3.10.4 Conversion power

The conversion power corresponding to electromechanical energy conversion in the machine is given by:

$$\text{On the electrical side : } P_C = E_A \cdot I_A$$

On the mechanical side : :  $P_C = \omega_r \cdot T$

Note that  $P_C = E_A \cdot I_A = (k \cdot K \cdot I_A \cdot \phi) \cdot \omega_r = \omega_r \cdot T$

Using  $P_{in}$  to denote input power to the armature, and  $P_{out}$  to denote output power from the armature, we have:

Generator :  $P_{in} = \omega_r \cdot T = P_C$  ,  $P_{out} = V_A \cdot I_A = E_A \cdot I_A - I_A^2 \cdot R_A = P_C - P_{Cu}$

Motor :  $P_{in} = V_A \cdot I_A = E_A \cdot I_A + I_A^2 \cdot R_A = P_C + P_{Cu}$  ,  $P_{out} = \omega_r \cdot T = P_C$

$P_{Cu}$  is the total copper loss(or ohmic loss) in the armature.

### **Example 3 :**

A 6-pole machine has 53 slots with 8 conductors/slot. The flux per pole is 50 mWb, and the speed is 420 rpm. Calculate:

- 1. The number of turns per coil;
2.  $E_{coil}$ ,  $E_A$ ;
3.  $T_{coil}$ ,  $T$ ;
4. conversion power , If the winding is (a) simple lap winding;  
(b) simple wave winding.

Assume armature current to be  $I_A = 50$  A.

Solution: (a) simple lap winding

$2a = 2p = 6$ ,  $C = 53$ ,  $Z = 53 \times 8 = 424$  conductors,  $2C = Z/N = 2 \times 53 = 106 > N = 424/106 = 4$  turns/coil

$E_{coil} = N \times E_{loop} = 4 \times 4p \cdot n \cdot \phi = 16 \times 3 \times (420/60) \times 50 \times 10^{-3} = 16.8$  V.

$E_A = E_p = (C/2a) \cdot E_{coil} = 53 \times 16.8/6 = 148.4$  V.

Or  $E_A = \frac{2pCN}{a} n \cdot \phi = 148.4$  V.

$T_{coil} = N \times T_{loop} = 4 \times \frac{pN}{\pi a} \cdot I_A \cdot \phi = 3.183$  N.m

$T = C \cdot T_{coil} = 53 \times 3.183 = 168.7$  N.m

$P_C = E_A \cdot I_A = 148.4 \times 50 = 7420$  W.

.(b) Simple wave winding

$$2a=2, E_{\text{coil}}=16.8 \text{ V.}$$

$$E_A=E_p=53 \times 16.8/2=445.2 \text{ V.}$$

$$T_{\text{coil}}=N \cdot T_{\text{loop}} = \frac{pN}{\pi a} \cdot I_A \cdot \phi = 9.549 \text{ N.m}$$

$$T=C \cdot T_{\text{coil}}=506.11 \text{ N.m}$$

$$P_c = E_A \cdot I_A = 22260 \text{ W.}$$

### **Tutorial 3 :**

A 6-pole , 1500 rpm dc machine is lap wound with 732 active conductors ,each carrying 20 A. The flux per pole is 30 mWb. (a) find  $I_A$  ,  $E_A$  ,  $T$  and  $P_c$ .

.(b) Repeat part (a) if the machine is reconnected in simple wave.

### **Example 4:**

A 10-pole simple lap wound generator is rated at 110 V., 600 A., and 750 rpm. It has a winding resistance of 7.2 m $\Omega$ , and is wound in 163 slots with 4 coil sides/slot and 2 turns/coil. Assume a brush voltage drop of 1.5 V. (a) find the rated load power, (b) find the resistance , emf, and terminal voltage per coil and per turn, and (c) find the developed torque and flux per pole.

### **Solution:**

$$P_{\text{out}}=V_A \cdot I_A=110 \times 600=66 \text{ KW}$$

$$2a=2p=10$$

$$R_p=R_A \times 10=72 \text{ m}\Omega$$

Coil sides= S X coil sides/slot

$$2C=163 \times 4= 652 \text{ coil sides}$$

$$C= 326 \text{ coils}$$

$$\text{Coils/path}= 32.6$$

$$R_{\text{coil}} = \frac{R_p}{\text{coils/path}} = 72/32.6 = 2.2 \text{ m}\Omega$$

$$E_A = V_A + I_A \cdot R_A + V_{\text{brushes}} = 110 + 600 \times 0.0072 + 2 \times 1.5 = 117.32 \text{ V} = E_p$$

$$E_{\text{coil}} = \frac{E_p}{\text{coils/path}} = 117.32/32.6 = 3.55 \text{ V} = 4pNn\phi \gg \gg \gg \phi = 7.1 \text{ mWb.}$$

$$V_{\text{coil}} = E_{\text{coil}} - I_p \cdot R_{\text{coil}} = 3.417 \text{ V.}$$

$$V_{\text{turn}} = E_{\text{turn}} - I_p \cdot R_{\text{turn}} = 1.78 - 60 \times 1.1 \times 10^{-3} = 1.714 \text{ V.}$$

$$T = K \cdot I_A \cdot \phi = \frac{pCN}{\pi a} \cdot I_A \cdot \phi = 5 \times 326 \times 2 \times 600 \times 7.1 \times 10^{-3} / 5\pi = 884 \text{ N.m}$$

#### **Tutorial 4:**

Repeat the same requirement in Ex. 4, if the flux and speed are kept the same, for wave winding.

## **CHAPTER 4**

## **THE MAIN FIELD**

The operation of dc machines is based on the interaction between the armature conductors and the air gap field, which results in induced emf and developed torque. The main field is the field produced by the field coils (or PM's) on the stator.

To be able to study the main field by itself, we shall assume there is no armature current, i.e. the machine is operating at no load.

### **4.1 Main field distribution**

If the field coils act alone (i.e. no current in armature conductors), the flux in the dc machine will have the general pattern, such that most of the flux in the pole cores crosses the air gap to link the armature windings; this is the useful flux per pole  $\phi$ . However, some of the flux lines complete their paths without linking the armature wdg; this is the leakage flux.

The useful flux  $\phi$  is produced by the mmf of the field coils. The mmf per pole  $M_f$  is the sum of the mmf's of all coils placed on one pole (which may be one, or two, or more). Thus

$$M_f = \sum N_f \cdot I_f \text{ ampere-turn/pole}$$

If you follow the lines of the useful flux, you will find that the path of the useful flux is composed of the following parts in series : stator yoke , pole core, pole shoes, air-gap, armature teeth, and armature core. As a series circuit, the over-all reluctance is dominated by the highest reluctances in the path, which are (a) the air-gap, and (b) armature teeth(when saturated).

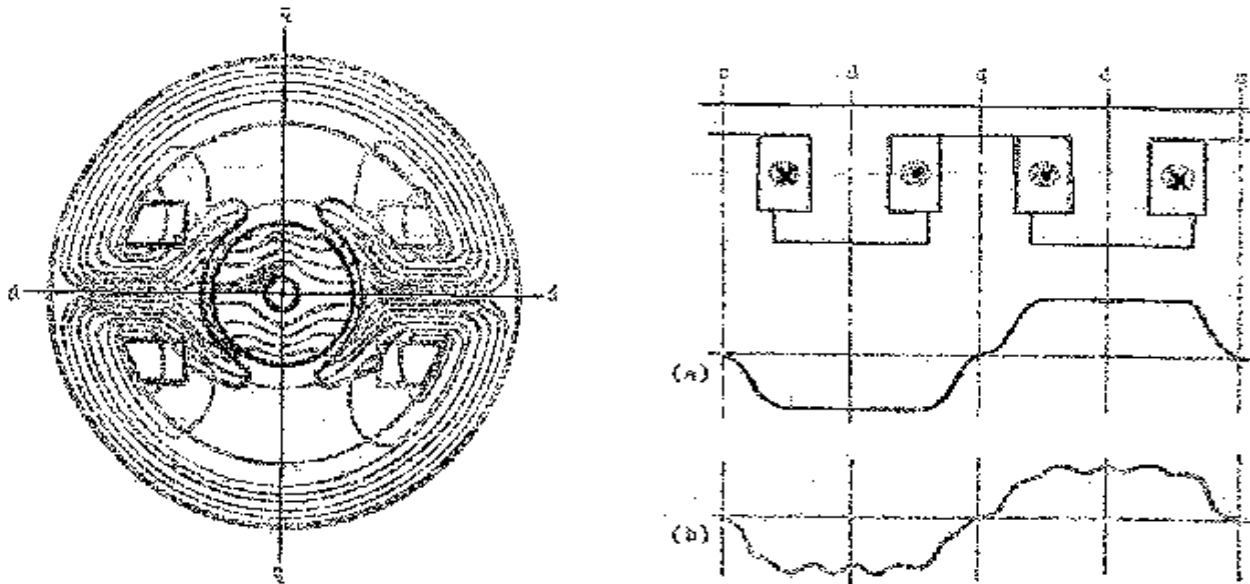

The figure on the LHS shows the flux distribution all over the machine, while the figure on the RHS shows the flux density distribution in the air gap, i.e. the effective field seen by the armature conductors. The curve is smooth if the armature surface is assumed to be smooth; in fact, armature slots introduce a ripple that moves along the curve as the armature rotates; we shall neglect the slotting effect. A much more serious distortion of the main field is caused by armature reaction.

#### 4.2 Field excitation

The main field may be produced by means of permanent magnets(PMDC), or by means of coils placed on the poles (wound-pole). PM's are compact(small size), require no supply for the field, and are economical in operation (no ohmic losses); however, they are very expensive. Wound-pole machines are much cheaper, and allow control of the field; they are much more commonly used.

Field coils in wound-pole machines may be connected in various ways. They may be divided as follows:

Separately –excited: field coils supplied from separate source.

Self-excited: field coils are connected with the armature. They may be in parallel (shunt field), or in series. Compound machines have both shunt and series fields.

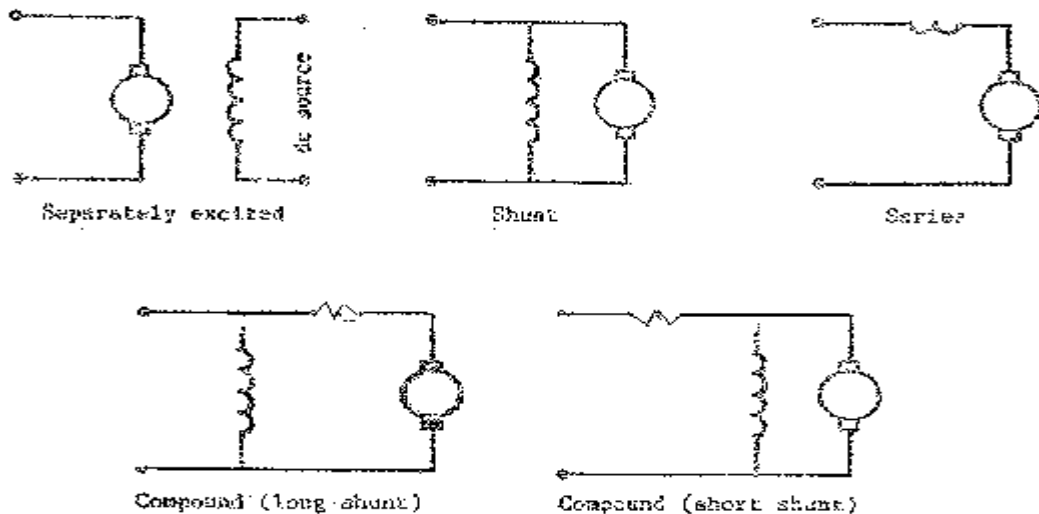

Shunt field coils are made of many turns of thin wire; they are designed to carry a current much smaller (less than 10%) than the armature current  $I_A$ . The shunt field current may be controlled by connecting a variable resistor (rheostat) in series with the coils.

Series field coils are made of just a few turns of thick wire; they carry the armature current  $I_A$  (in short-shunt compound machines, the series field current differs from the armature current by an amount equal to the shunt field current, which is small). The series field current may be controlled by placing a variable resistor in parallel with the coils.

Compound machines may be connected in long-shunt or in short-shunt. There is no major difference between the two types of connection. The shunt and series coils may produce fields that aid each other, and compounding is said to be cumulative; conversely, the shunt and series fields may oppose each other, and the compounding is then said to be differential. In general, the shunt field is substantially greater than the series field, and hence dominates.

From the above, it should be clear that the resistance of shunt field coils is quite large, while that of series field coils is quite small. Moreover, control of the field current results in control of the induced emf, and hence control of general machine operation.

Some special-purpose dc machines have more than two sets of field coils; each set of coils is fed from a different controlling signal, so that motor operation is determined by the over-all combination of controlling signals. Such motors are commonly used in control applications.



### 4.3 The magnetization curve

In wound-pole machines, the flux is produced by the field excitation, i.e. by the mmf of the field coils. The magnetization curve is the relationship between the flux per pole  $\phi$  and the mmf per pole  $M_f$  producing it.

$M_f$  is applied to a magnetic circuit composed of the air-gap reluctance in series with the reluctance of iron parts (assuming the leakage flux is negligible). The air-gap reluctance is constant, but the reluctance of iron parts increases as they enter into saturation.

At low excitation (say  $M_{f1}$ ), the iron is unsaturated so that its permeability is very high, and its reluctance is negligible relative to that of the air-gap; the mmf drop in the iron is negligible, and practically all the applied mmf  $M_{f1}$  is taken up in driving the flux  $\phi_1$  across the air-gap. At higher excitation (say  $M_{f2}$ ), iron parts begin to saturate so that their permeability goes down and their reluctance goes up; the mmf drop in the iron is no longer negligible relative to the mmf drop in the air-gap. The applied mmf  $M_{f2}$  divides between the air-gap and the iron according to the ratio of their reluctances (similar to voltage division in electric circuits). As the excitation is increased further (to, say,  $M_{f3}$ ), the iron parts are driven further into saturation so that they consume a larger proportion of the applied mmf  $M_{f3}$ ; indeed, the mmf drop in iron may become greater than the mmf drop in the air-gap. Armature teeth saturate first, followed by the poles, and then the armature core and yoke.

The relationship between the flux per pole  $\phi$  and the mmf drop in the air-gap (which is less than  $M_f$ ) is linear; it is represented by the air-gap line in fig.4.4. At low excitation, the magnetization curve follows the air-gap line. As excitation increases, the machine begins to saturate, and the curve moves away from the line (knee of the curve). At heavy excitation, the machine is well into saturation, and the curve is well away from the line. It is noted that at zero field excitation, there is some remanent magnetism (due to hysteresis in the iron) so that the flux  $\phi$  is not zero.

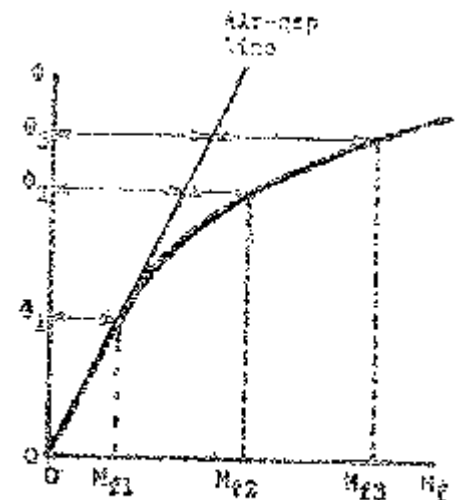

Fig. 4.4 Magnetization curve,  $\phi$  vs.  $M_f$ .

Now, from chapter 3, we have

$$E_A = K_e \cdot n \cdot \phi = K \cdot \omega_r \cdot \phi \quad \text{and} \quad T = K \cdot I_A \cdot \phi$$

Where  $K_e$  and  $K$  are constants depending on machine parameters. If  $\phi$  is known, then  $E_A$  may be computed for a given speed  $n$ , and  $T$  may be computed for a given  $I_A$ . However, if it is the

field excitation  $M_f$  that is known, we must first find  $\phi$  from the magnetization curve; the procedure is graphical because there is no ready formula giving  $\phi$  in terms of  $M_f$ .

At a given constant speed  $n_o$

$$E_{A0} = K_e \cdot n_o \cdot \phi$$

So that the vertical axis of the magnetization curve may be scaled in terms of  $E_{A0}$  instead of  $\phi$ . If, moreover, only one field winding (i.e. one set of field coils) is excited, then

$$M_f = N_f \cdot I_f$$

Where  $N_f$  and  $I_f$  correspond to the wdg excited; since  $N_f$  is constant, the horizontal axis of the magnetization curve may be scaled in terms of  $I_f$  instead of  $M_f$ . These forms of the magnetization curve are shown in fig.s 4.5 and 4.6 respectively. The last form of the magnetization curve ( $E_A \times I_f$ ) can be obtained experimentally by the simple test shown in fig. 4.8: the machine is driven at constant speed  $n_o$ ; the field current  $I_f$  is varied, and the corresponding values of emf  $E_{A0}$  are recorded. If the test is performed at rated speed, the resulting magnetization curve is called the open circuit characteristic (OCC).

To obtain the magnetization curve at different speeds as in fig. 4.7, we need to perform the (open circuit) test only once at, say,  $n_o$ ; at a given value of field current, say  $I_{f0}$ , we have

$$E_{A1} = k_e \cdot n_1 \cdot \phi = K_e \cdot n_o \cdot \phi (n_1/n_o) = E_{A0} (n_1/n_o)$$

Thus the emf values at  $n_1$  are obtained by multiplying the corresponding emf values at  $n_o$  by the speed ratio ( $n_1/n_o$ ).

If the OCC is available, the magnetization curve  $E_A$  vs.  $M_f$  may be obtained if  $N_f$  is known, and the magnetization curve  $\phi$  vs.  $M_f$  may be obtained if  $K_e$  or  $K$  is known.

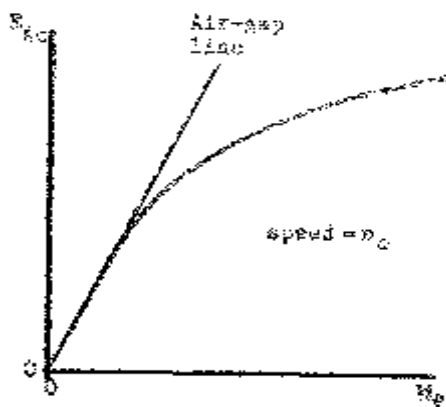

Fig. 4.5 Magnetization curve,  $E_{A0}$  vs.  $M_f$

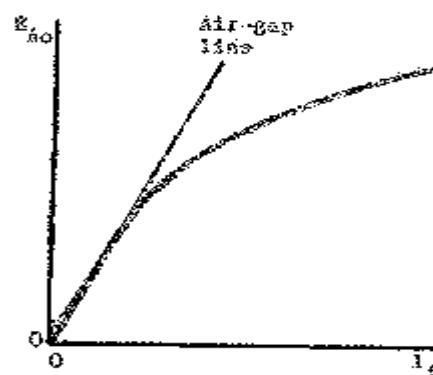
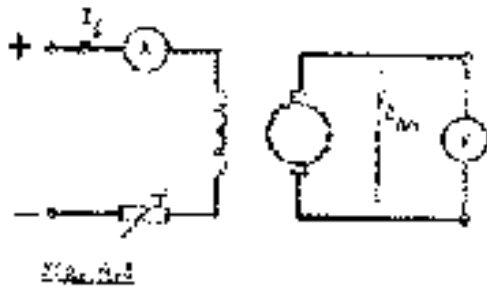

Fig. 4.6



Test to measure OCC ; machine driven at constant speed  $n_0$

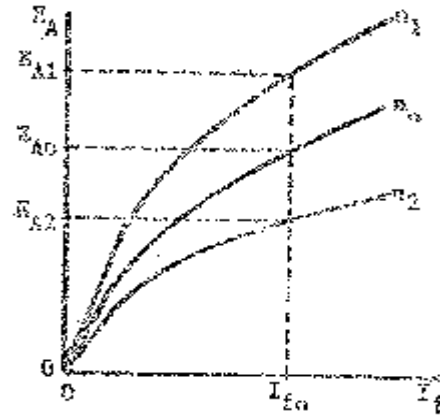

Fig. 4.7

$$n_1 > n_0 > n_2$$

## Chapter 5

### Armature Reaction

When a machine is loaded, currents will flow in the armature coils, and an armature field is set up. This armature reaction distorts the field distribution in the machine, and results in some adverse effects that must be treated for satisfactory operation.

#### 5.1 Armature field

When the machine is loaded, current flows in the armature conductors, and tends to set up a magnetic field as shown in fig. 5.1. The armature may be viewed as a single coil acting in the q-axis ; most of the flux follows the path composed of : arm teeth, air-gap , pole shoes , and arm core. Note in particular that the arm field is perpendicular to the main field shown in fig. 4.1 and repeated here in fig. 5.3, which acts in the d-axis. The armature mmf is distributed along the air-gap as shown in fig. 5.2 (with the actual slots approximated by a continuous belt of current). The arm mmf  $M_a$  peaks at the q-axis and is zero at the d-axis; its peak value is

$$M_{am} = \frac{1}{2} \cdot \frac{Z}{2p} \cdot \frac{I_A}{2a} = \frac{Z}{8pa} \cdot I_A = \frac{NC}{4pa} \cdot I_A$$

The arm mmf tends to set up the air-gap flux density distribution shown in fig. 5.2 ; although the mmf is maximum at the q-axis , the flux density is seen to fall because of the large reluctance there resulting from the long air path.

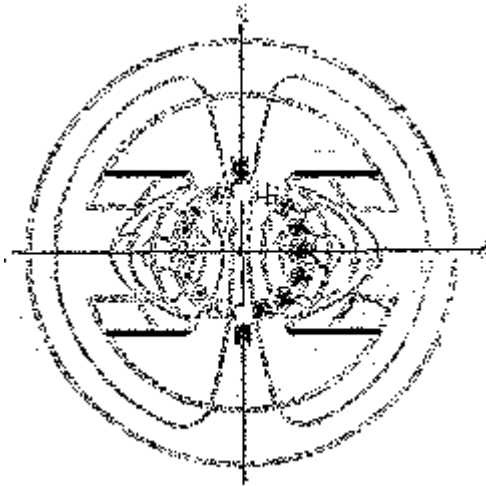

Fig. 5.1

Fig. 5.3

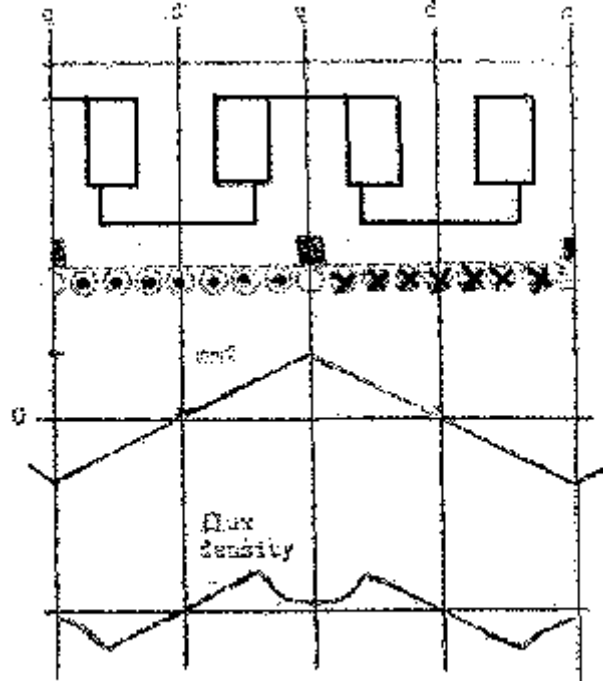

Fig. 5.2

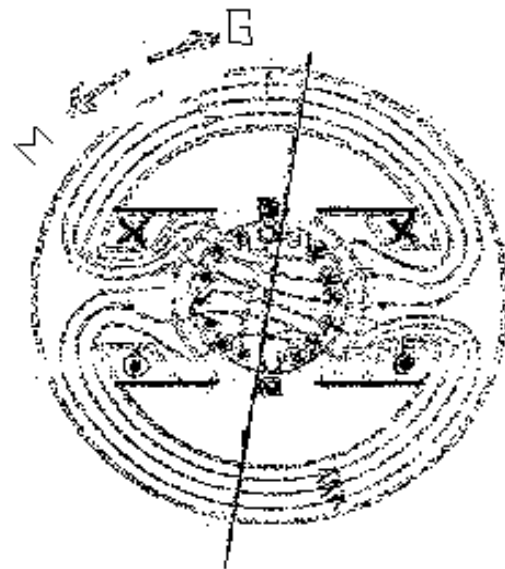
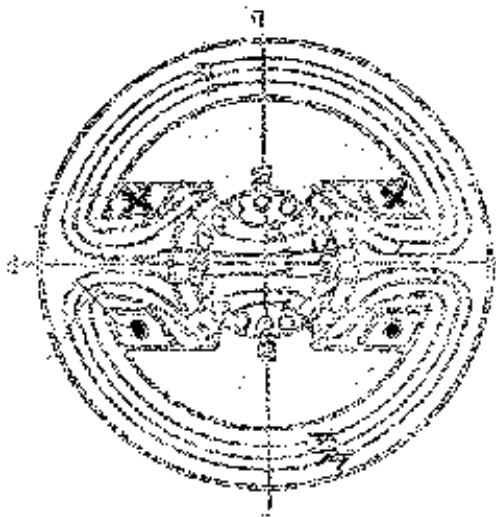

Fig. 5.4 Resultant flux distribution

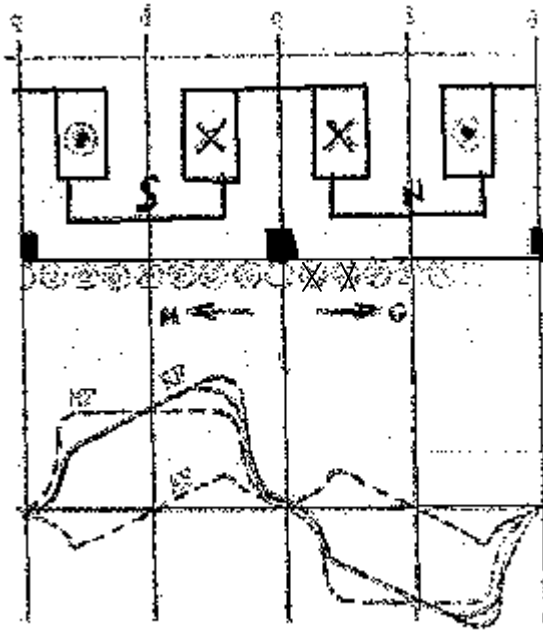

Fig. 5.5 Air-gap flux density distribution

MF: main field;

AF: armature field;

RF: resultant field

## 5.2 Resultant field

Fig. 5.1 shows the arm field by itself, while fig. 5.3 shows the main field by itself. Note that the main field acts along the d-axis, while the arm field acts along the q-axis. In the arm core and pole shoes, the two fields are perpendicular to each other. In the air-gap, however, the arm field aids the main field over a half pole-pitch, and opposes it over the next half pole-pitch. Superposition of the two fields yields the resultant flux distribution shown in fig. 5.4; this is the actual distribution in the machine when both armature and main fields are present, i.e. both arm and field wdgs are excited. Note how armature reaction has distorted the field distribution; note, in particular, how the magnetic neutral axis is now shifted from the q-axis (or mechanical neutral axis, or brush axis). The air-gap flux density is strengthened in one pole tip and weakened in the other pole tip, as shown in fig. 5.5. The zero-crossing of the flux density wave is now shifted from the q-axis.

The directions of main field and arm currents in fig. 5.4 correspond to (a) generator operation for CW arm rotation, or to (b) motor operation for CCW arm rotation; this is easily verified by

noting that the torque on the arm conductors is CCW. It is thus seen, from fig.5.4 or 5.5 , that the flux is “pulled” in the direction of rotation for generator operation, and in the direction opposite to rotation for motor operation; thus the shift in the magnetic neutral axis is in the direction of rotation for generator operation, and in the direction opposite to rotation for motor operation.

### 5.3 Demagnetizing effect

The arm reaction acts on the q-axis and is therefore generally perpendicular to (or “in quadrature with”) the main field which acts on the d-axis; it is thus called “ cross-magnetizing” armature reaction. For a linear magnetic circuit, the cross-mag arm reaction has no effect on  $\phi$  , the useful flux per pole: the arm mmf in one half pole-pitch is equal and opposite to the arm mmf in the other half ; therefore it adds and subtracts equal amounts to the main flux which thus remains unchanged. It follows that the average emf  $E_A = k \cdot \omega_r \cdot \phi$  and the average torque  $T = K \cdot I_A \cdot \phi$  are unaffected by cross-mag AR because  $\phi$  itself is unaffected. However, because of the distortion of the air-gap flux density, fig. 5.5 , the instantaneous emf and torque are no longer the same for all conductors under the pole face.

But the magnetic circuit is actually nonlinear because it includes iron parts which tend to saturate at high fields. In the half pole-pitch where the arm mmf aids the main field, the iron parts (arm teeth and pole tips) are driven deeply into saturation so that the increase in flux density there is less than the decrease in flux density in the other half pole pitch( where arm mmf opposes main field so that iron parts are driven down the knee of the mag curve into the linear part). This means that the peaks of the distorted flux density wave are chipped off as shown by dotted curves in fig. 5.5 . It also means that there is a net decrease in  $\phi$  ; i.e. cross-magnetizing AR has a demagnetizing effect. The decrease in  $\phi$  results in reduction of the average emf  $E_A$  and average torque  $T$ .

Clearly, then, the effective magnetization curve on load ( $I_A > 0$ ) lies somewhat below the OCC ( $I_A = 0$ ), and is lower for higher armature currents; see fig. 5.6 . The curves merge with the OCC at the air-gap line because there is no saturation at low excitation.

The reduction in the useful flux due to AR is a nonlinear function of both field and armature mmf's, and hence of field and armature currents,  $I_f$  and  $I_A$ . The demagnetizing effect of AR may be represented as a reduction in induced emf,  $\Delta E$  , or as a reduction in effective field current,  $\Delta I_f$ ; see fig. 5.7 . At a field current  $I_f$  and zero arm current  $I_A = 0$ , we have

$$V_A = E_A \quad \text{and} \quad E_A = E_{Aoc} \quad \text{then} \quad V_A = E_A = E_{Aoc}$$

At the same field current  $I_f$ , but with an on-load arm current  $I_A \neq 0$ , we have

$$V_A = E_A \pm I_A \cdot R_A \quad \text{and} \quad E_A = E_{Aoc} - \Delta E \gggggg V_A = ( E_{Aoc} - \Delta E ) \pm I_A \cdot R_A$$

$$\text{Or } V_A = E_{AOC} \pm (I_A \cdot R_A \pm \Delta E)$$

Thus we may view  $E_{AOC}$  as the induced emf, and  $\Delta E$  as a voltage drop that subtracts from the arm resistance drop  $I_A \cdot R_A$  for motor operation, and adds to it for generator operation. Alternatively, we might view  $AR$  as a reduction in effective field mmf: at a field current  $I_f$  and an arm current  $I_A$ , the effective field current is

$$I_f' = I_f - \Delta I_f$$

On the OCC,  $I_f'$  gives the actual induced emf  $E_A$ , while  $I_f$  gives the emf  $E_{AOC}$  which would be induced when the load is removed.

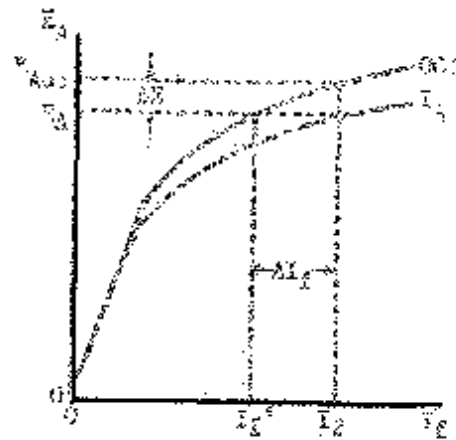
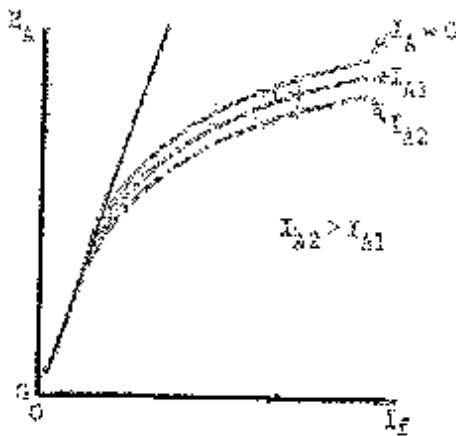

Fig. 5.6 Effect of load on magnetization curve. Fig. 5.7 Representation of

Demagnetizing effect of armature

Reaction.

### Exercise

The OCC of a dc machine running at 800 rpm is given in the table below. Plot it, (a) on the same graph, plot the curves at 600 rpm and at 1000 rpm. (b) if each field coil has 630 turns, plot the magnetization curves  $E_A$  vs.  $M_f$ . (c) if the machine is wave wound with 6 poles, and has 46 armature coils of 3 turns each, plot the magnetization curve as  $\Phi$  vs.  $M_f$ . (d) at 800 rpm, estimate the mmf drops in the air-gap and in the iron when the emf is 50,100,150,200,250, and 00 volts. (e) what is the

residual (or remanent) flux per pole? (f) what is the induced emf when the field current is 5.5 A. and the speed is 1500 rpm?.

$I_f$ (amps)	0	.3	.5	1	1.5	2	2.5	3	3.5	4	4.5	5	6	7	8	9	10
$E_A$ (volts)	8	28	46	94.5	143	175	195.5	211	224	24.5	248.5	251.5	265	276.5	286	294	302

The dc machine whose OCC is given in the above table has a wdg resistance of  $75 \text{ m}\Omega$  and a constant brush contact drop of  $1.5 \text{ V}$ . The mag curves at different armature loadings and constant speed  $800 \text{ rpm}$  are listed in the table given below. Plot these curves, together with the OCC. Over the field current range shown here. (a) determine  $\Delta E$ , and  $\Delta I_f$  when the arm current is  $80 \text{ A}$  and the field current is  $8 \text{ A}$ . (b) determine the terminal voltage when the field current is  $7 \text{ A}$  and the arm current is  $60 \text{ A}$ , and the machine is operating as a generator. (c) repeat part b for motor operation. (d) if the machine is operating as a generator with terminal voltage  $260 \text{ V}$  and armature current  $100 \text{ A}$ , fi

$I_f$		3.5	4	4.5	5	6	7	8	9	10
$E_A$	$I_A = 100$	217	225.5	232.5	239.5	252	262.5	270.5	277	283
	$I_A = 80$	219	228	235.5	243	256	267	275.5	283	290
	$I_A = 60$	221	230.5	238.5	246.5	260	271.5	280.5	288.5	296



#### 5.4 Effects of armature reaction

The distortion of the field due to AR has a number of adverse (bad) effects:

- (1) Demagnetizing effect as discussed in section 5.3 : as arm current increases, the useful flux per pole decreases, and hence the induced emf and developed torque decrease.
- (2) Shift of the magnetic neutral axis from the brush axis means that coil sides of coils undergoing commutation are subjected to nonzero flux density, so that a nonzero emf is induced in them .
- (3) AR concentrates the flux at one pole tip, fig. 5.5 . Although the average emf is approximately the same (slightly reduced- fig. 5.6 ), the instantaneous emf is increased for coils whose sides are passing under these tips; the increase can be quite large, especially if the machine is overloaded (large  $I_A$ ) . These coils are connected to commutator segments that are near the brushes where the air is highly ionized due to normal sparking. High inter-segment voltage applied to ionized air can cause breakdown of the air (arcing between segments). This may cause further ionization and further arcing; in severe cases it may result in total flashover from brush to brush. The heat from the arc can damage the brushes and melt holes in the commutator.

Clearly, then , AR can have serious consequences that limit the operational conditions of the machine. The design and construction of the machine must therefore aim at reducing armature reaction:

- (1) Machines are designed to have a strong main field so that relative distortion due to AR remains small.
- (2) The machine is designed to have a high reluctance in the path of the armature cross-flux (arm teeth, air-gap, pole shoes-see fig. 5.1).

This may be done by constructing poles with alternate laminations as in fig. 5.9: with the amount of iron in the pole tips reduced, the flux density is increased, and the tips are driven quickly into saturation, and hence high reluctance. Alternatively , the air-gap under pole tips is made longer by using poles with eccentric pole faces as in fig. 5.9( or chamfered faces). The increased reluctance also reduce the main flux, but the reduction is much smaller than the reduction in the armature cross-flux.

- (3) To avoid flashover the instantaneous voltage between commutator segments must not exceed 30-40 volts. Machines are therefore designed to have an average voltage between segments not exceeding 20-30 volts.

(4) In some machines, the pole shoes are made with slots in which an additional winding is placed, fig. 5.10. The currents in these “pole-face wdg’s” or “compensating wdg’s” are arranged to flow in directions opposite to those of armature conductors, so that their mmf’s cancel out under the pole-face as shown in fig. 5.10.

Compensating wdg’s are connected in series with the armature, fig. 5.11, so that cancellation occurs for all loads (as  $I_A$  increases,  $A_R$  will increase, but so will the compensating wdg mmf also).

For full compensation, we must have

$$\left(\frac{1}{2} N_c\right) \cdot I_A = \alpha \left(\frac{Z}{8p\alpha}\right) \cdot I_A \quad \gggggg \quad N_c = \alpha \cdot Z / 4p\alpha = \alpha \cdot NC / 2p\alpha$$

Where  $N_c$  = compensating winding conductors per pole, and  $\alpha$  = pole arc/pole pitch.

Computing  $N_c$  in this way, it is unlikely to come out an integer; a smaller integer number is used because 60-70% compensating is usually sufficient. Compensating wdg’s are very expensive to install; they are economically justified only in very large machines, and in some special-purpose machines.

Fig. 5.8  $V_A = E_A \pm I_A \cdot R_A$

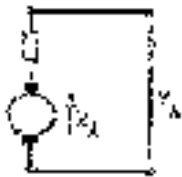

Alternate pole laminations



Eccentric pole face

Fig. 5.9 methods of increasing reluctance at pole tips

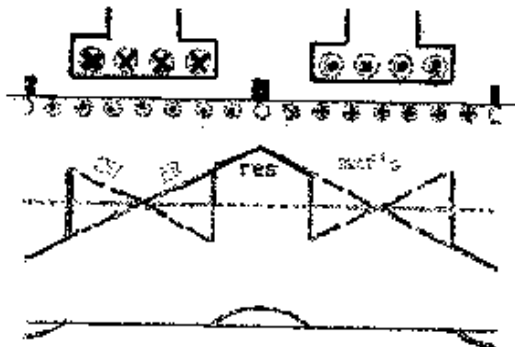

Fig. 5.10 compensating effect of pole-face wdg

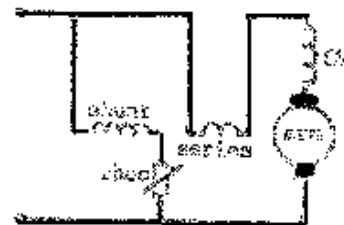

Fig. 5.11 dc M/C with CW

### 5.5 Brush shift

Sometimes brushes are not in the exact neutral position (q-axis). Such brush shift may be (a) unintentional : incorrect positioning in manufacture, or poor brush fit, etc., or it may be (b) intentional : in very old machines and in some very small machines, brushes are shifted to improve commutation. With the brushes thus shifted, the arm field is no longer in strict quadrature with the main field (i.e. d-axis), fig. 5.12. The d-axis component of the arm field may oppose (demagnetizing) or aid (magnetizing) the main field; this depends on the direction of brush shift relative to rotation, and on the mode of operation, generating or motoring; see fig. 5.12.

To test for correct positioning of brushes, the machine is rotated in both directions as a loaded generator; if the load, speed, and field excitation are the same for both directions of rotation, the terminal voltage will be the same if the brushes are correctly placed. If, however, the brushes are not at the exact neutral position, the terminal voltage will differ for the two directions of rotation.

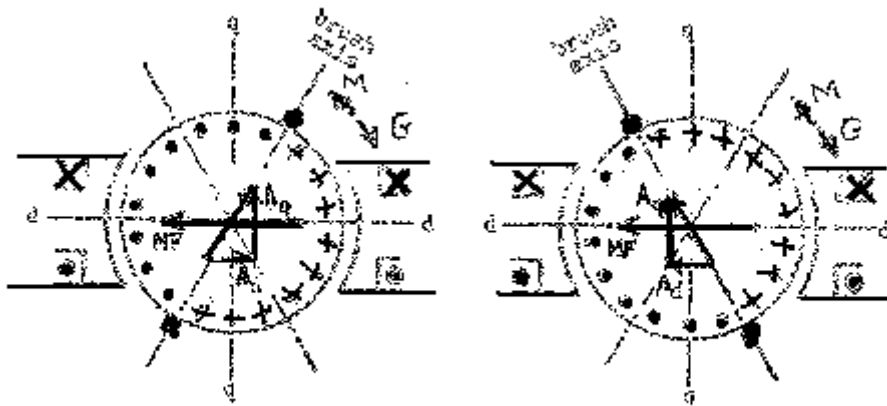

Fig. 5.12 Effect of brush shift. MF: main field; AF: armature field;  $A_d$  &  $A_q$  = direct & quadrature components of armature field.

## CHAPTER 6

**Commutation**

The commutator is a characteristic feature of dc machines. Its purpose is to match the alternating currents and voltages of the armature coils to the direct current and voltage of the brushes as already explained in chapters 1 and 3. However, the commutation process is quite complicated, and gives rise to secondary effects that place limits on the over-all performance of the machine.

**6.1 The process of commutation**

Fig. 6.1 shows a general arm coil C moving to the right as it rotates with the armature; it is connected to commutator bars a and b which move with it. (a) when the coil sides are under the poles, the coil is part of a certain armature path and carries a path current  $I_a$

$$I_a = \frac{I_A}{2a}$$

-(b) As the coil sides approach the q-axis (or brush axis), there will be an instant  $t_1$  at which the brush contacts bars a and b simultaneously; thus starts the short circuit of the coil by the brush. (c) The coil continues to be short-circuited by the brush; it is said to be 'undergoing commutation'. (d) As coil sides move away from the q-axis, there will be an instant  $t_2$  at which bar b breaks contact with the brush so that the short circuit ends. (e) Coil sides move under poles, and the coil is now part of a different path; the coil current is  $I_a$  again, but in a direction opposite to the original one.

Clearly, then, the coil is short-circuited for an interval  $T_c$

$$T_c = t_2 - t_1$$

During this interval, the coil current changes from  $I_a$  to  $-I_a$ ; i.e. it reverses or

'commutates'. As shown in fig. 6.2, the change in current must follow some time-curve from the point  $(t_1, I_a)$  to the point  $(t_2, -I_a)$ . Depending on various conditions that will be explained in later sections, we may have linear commutation (curve 1), over-commutation (curve 2), or under-commutation (curve 3).

To calculate the SC interval (or commutation interval), let  $u_c$  denote the speed of the bars; thus

$$u_c = 2\pi r_c n$$

where  $r_c$  is the radius at the commutator surface. From fig. 6.3, it is seen that the leading edge of bar a moves from  $x_1$  at  $t_1$  to  $x_2$  at  $t_2$ ;

Thus

$$u_c = \frac{x_2 - x_1}{t_2 - t_1} = \frac{w - y_i}{T_c}$$

Therefore

$$T_c = \frac{w - y_i}{u_c} = \frac{1}{2\pi r_c n} \left( \frac{w}{y_o} - \frac{y_i}{y_o} \right) y_o = \frac{1}{n C} \left( \frac{w}{y_o} - \frac{y_i}{y_o} \right) \quad (y_o = \frac{2\pi r_c}{C})$$

As expected, the length of the SC interval,  $T_c$ , is determined by the speed of rotation  $n$ , the relative dimensions of bars and brush, and the number of commutator bars.

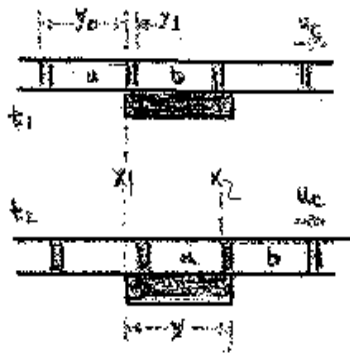

Fig. 6.3 aid to calculate  $T_c$

Fig. 6.1 The process of commutation >>

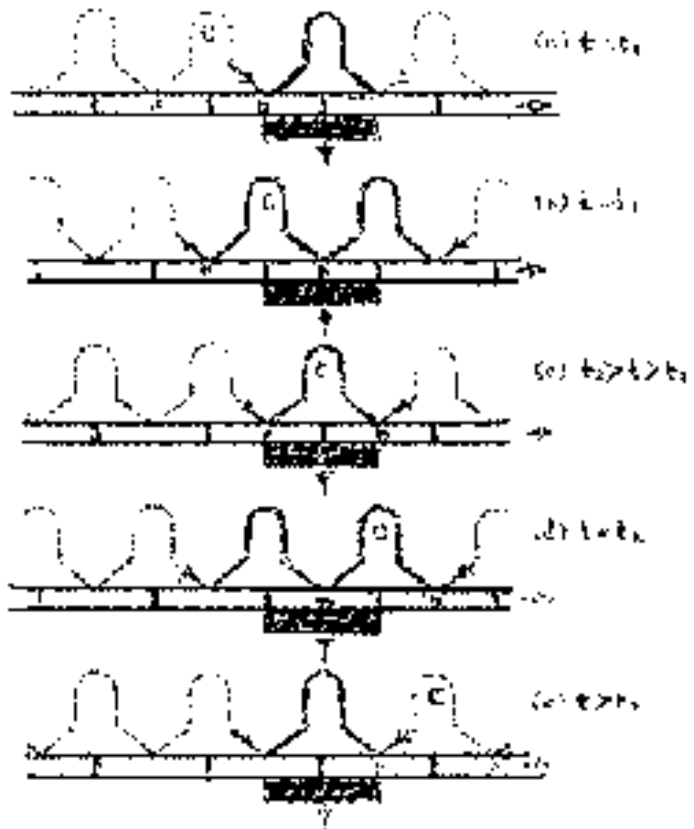
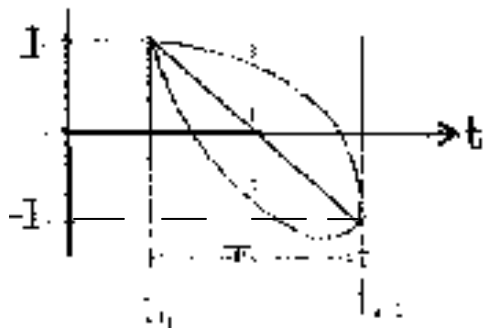

Fig. 6.2 Reversal of current in coil undergoing commutation



## 6.2 Equivalent circuit of commutating coil

During commutating, the coil SC current  $i_s$  circulates in a path composed of: the coil itself, risers, bars, contact surfaces, and brush (see fig. 6.4). A simplified equivalent circuit is shown in fig. 6.5 with:

$R_c$  = coil resistance;

$E_c$  = rotational emf in coil =  $2N(B.L.u)$

$L_c$  = self inductance of coil;

$r_1$  = contact resistance between brush and trailing bar;

$r_2$  = contact resistance between brush and leading bar.

The circuit of fig. 6.5 involves the following simplifications:

1. the resistance of riser, bar, and brush is negligible w.r.t contact resistance;
2. mutual inductance with adjacent coils is neglected;
3. brush assumed to short circuit one coil at a time.

Note that lower-case symbols are used for quantities that are time varying during  $T_c$ ; these are  $e_c$ ,  $i_s$ ,  $i_1$ ,  $i_2$ ,  $r_1$ , and  $r_2$ ; indeed,  $i_s$  and possibly  $e_c$  reverse during  $T_c$ . Also note that from KCL

$$i_1 = I_a - i_s \quad \text{and} \quad i_2 = I_a + i_s$$

so that

$$i_1 + i_2 = 2I_a$$

as expected.

The terminal voltage of the coil  $v_c$  is given by

$$V_c = e_c - i_s R_c - L_c (di_s/dt)$$

The rotational emf  $e_c$  is small because field is small around the q-axis (see, for example, fig. 5.5).  $L_c (di_s/dt)$  is called the reactance voltage; it is induced by the change in  $i_s$ .

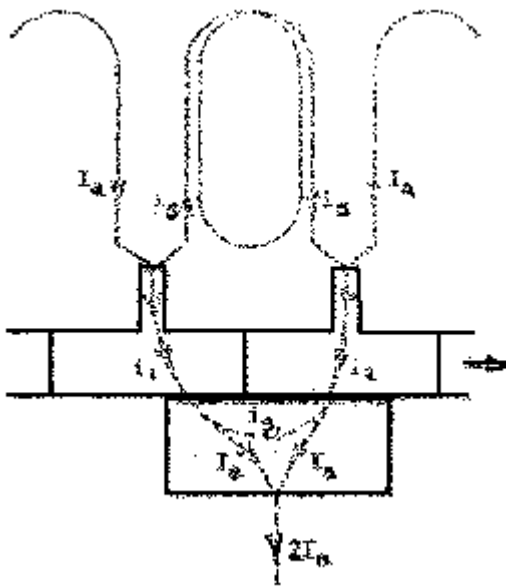

Fig. 6.4 current distribution in brush and  
Commutating coil.

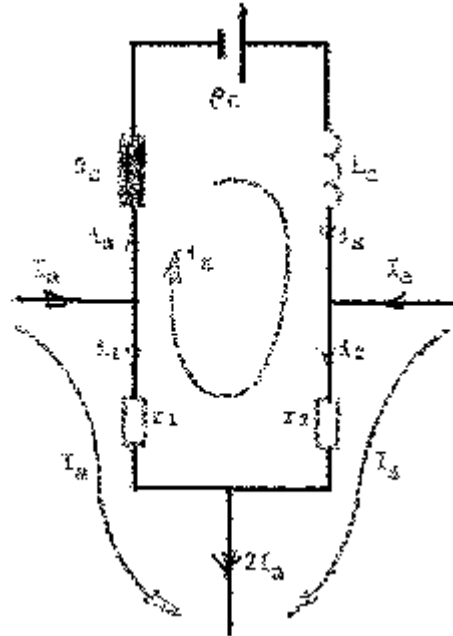

Fig. 6.5 Equivalent circuit for brush  
And commutating coil.

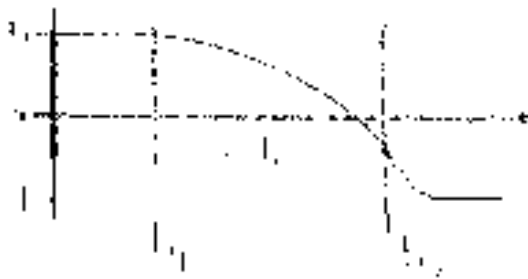
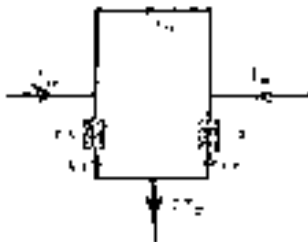

Figure 6.6, Fig. 6.7 , & Fig. 6.8

### 6.3 Linear commutation (resistance commutation)

In small machines, the coil voltage  $v_c$  is smaller than the contact drops  $i_1 r_1$  and  $i_2 r_2$ . If we assume that  $v_c$  is negligibly small, then the equivalent circuit of fig. 6.5 reduces to that of fig. 6.6. In this case,  $r_1$  and  $r_2$  are in parallel so that by current division

$$\frac{i_1}{i_2} = \frac{r_2}{r_1}$$

If we further assume that  $r_1$  and  $r_2$  are linear resistances (which in fact they are not), then

$$\frac{r_1}{r_2} = \frac{A_2}{A_1}$$

Where the contact areas  $A_1$  and  $A_2$  are defined in fig. 6.7. Thus

$$\frac{i_1}{i_2} = \frac{A_1}{A_2}$$

i.e. the current division between bars is in direct proportion to their respective contact areas. If in the above expression we substitute for  $i_1$  and  $i_2$  in terms of  $I_a$  and  $i_s$  (see section 6.2), and rearrange, we get

$$i_s = \frac{A_2 - A_1}{A_b} I_a \quad (\text{derive this equation ?})$$

as the commutator slides against the brush at constant speed,  $A_1$  increases linearly with time, while  $A_2$  decreases linearly with time. Thus  $i_s$  varies linearly from  $I_a$  at  $t_1$  to  $-I_a$  at  $t_2$ , and we have linear commutation as in curve 1 of fig. 6.2. Linear commutation is also called resistance commutation because the current variation is controlled by the contact resistances  $r_1$  and  $r_2$  (see first equation in this section).

Note that we derived linear commutation as an approximation based on two assumptions: negligible  $v_c$  and linear contact resistances. These assumptions do not generally hold in practice so that we seldom have linear commutation. Commutation approaches linearity in small machines where these assumptions are approximately true.



#### 6.4 Reactance voltage

Reactance voltage is the voltage induced in the coil due to the time variation of  $i_s$ ; it appears across  $L_c$  in the equivalent circuit of fig. 6.5, and is equal to  $L_c (di_s/dt)$ . Reactance voltage has a great effect on commutation process, so that linear commutation (which is based on neglecting reactance voltage) is usually to be achieved in practice. The role of reactance voltage in the commutation process may be described qualitatively as follows:

The reactance voltage is induced by the change of coil current from  $I_a$  to  $-I_a$ . According to Lenz's law, the reactance voltage will be induced in such a way as to oppose what is causing it, i.e. it opposes the change in current. Therefore the reactance voltage retards or delays the change in current.

Due to RV, then, the current tends to follow a curve above that of linear commutation, for example curve 3 in fig. 6.2; the greater the coil inductance  $L_c$ , the higher the curve.

If current reversal is not complete (i.e. current has not reached  $-I_a$ ) when bar  $b$  breaks contact with the brush at  $t_2$ , the curve will be as shown in fig. 6.8. This results in sparking which is explained as follows:

At  $t_2$  the coil current attempts to jump to  $-I_a$  almost instantaneously. This results in very high RV (why?), which causes breakdown in the air. The arc provides a path between brush and bar  $b$  through which current flows to complete its reversal to  $-I_a$ .

Sparking is harmful because it causes heating and hence wear of both brush and commutator bars. It becomes more severe as load increases (as the armature current  $I_A$  increases, so does the path current  $I_a$ ).

#### Treatment of sparking

In some small machines, the resistive contact drop is much greater than the RV so that sparking is limited by the effect of resistance commutation, i.e. commutation approaches the linear case.

In larger machines, some additional means must be found to limit sparking, i.e. to counter the effect of RV which is the prime cause of sparking as explained above. Modern machines use interpoles, while older machines (and some small machines) use brush shift; these two methods are explained in the following sections:

#### 6.5 Interpoles (commutating poles, compoles)

Nearly all integral horsepower machines have interpoles (IP). IP are narrow poles with large air-gap placed between main poles as in fig. 6.9. Their coils are connected in series with the

armature so that the IP field is proportional to arm current  $I_A$  (the large air gap prevents saturation in the iron). The IP field acts on commutating coils at the q-axis.

The IP mmf  $M_i$  is given by

$$M_i = N_i I_A$$

Where  $N_i$  is the number of turns in each IP coil. The number of turns  $N_i$  is chosen to make the IP mmf some 25% greater than  $M_{am}$ , the cross-magnetizing armature mmf at the q-axis (see section 5.1); thus

$$M_i = 1.25 M_{am} \quad \text{so that} \quad N_i = 1.25 (NC/4pa)$$

In this way,  $M_i$  is made to serve two purposes: (1) the additional 25% neutralizes the commutating coil flux (which induces the RV). This is clear in fig 6.10 a,b, and c: the IP field not only reduces the q-axis field to zero, but drives additional flux in the negative direction to neutralize RV. Figs. 6.10 d and e show the resultant field in interpole machines, without and with compensating windings; compare them with figs 5.5 and 5.10 (NB IPs treat arm reaction in the q-axis, while compensating wdg's treat arm reaction under the poles).

As the machine is loaded, the armature current  $I_A$  increases so that armature reaction and RV increase; but the IP field is also  $\propto I_A$ , and will increase automatically to neutralize armature reaction (in the q-axis) and RV. IPs will continue to do their job properly for either mode of operation, motor or generator, and for either direction of rotation, forward or reverse.

Fig. 6.11 shows the general connection of a dc machine. Not all windings shown are present in all machines. IP or commutating wdg's are found on integral horsepower machines (rated power > one hp); compensating wdg's are found on large machines and on some special machines; many machines have only one main field wdg, shunt or series; compound machines have both. The terminals of main field wdg's (shunt and series) are usually brought out to the terminal box to allow user manipulation; the terminals of compensating and commutating wdg's are not brought out to the terminal box because they are permanently connected in series with the armature.

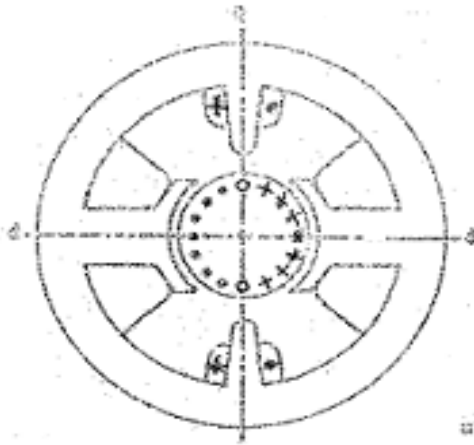

Fig. 6.9

Fig. 6.10  
Flux density  
distributions  
in the air gap  
of a dc machine.

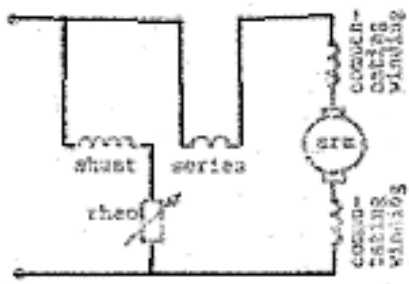
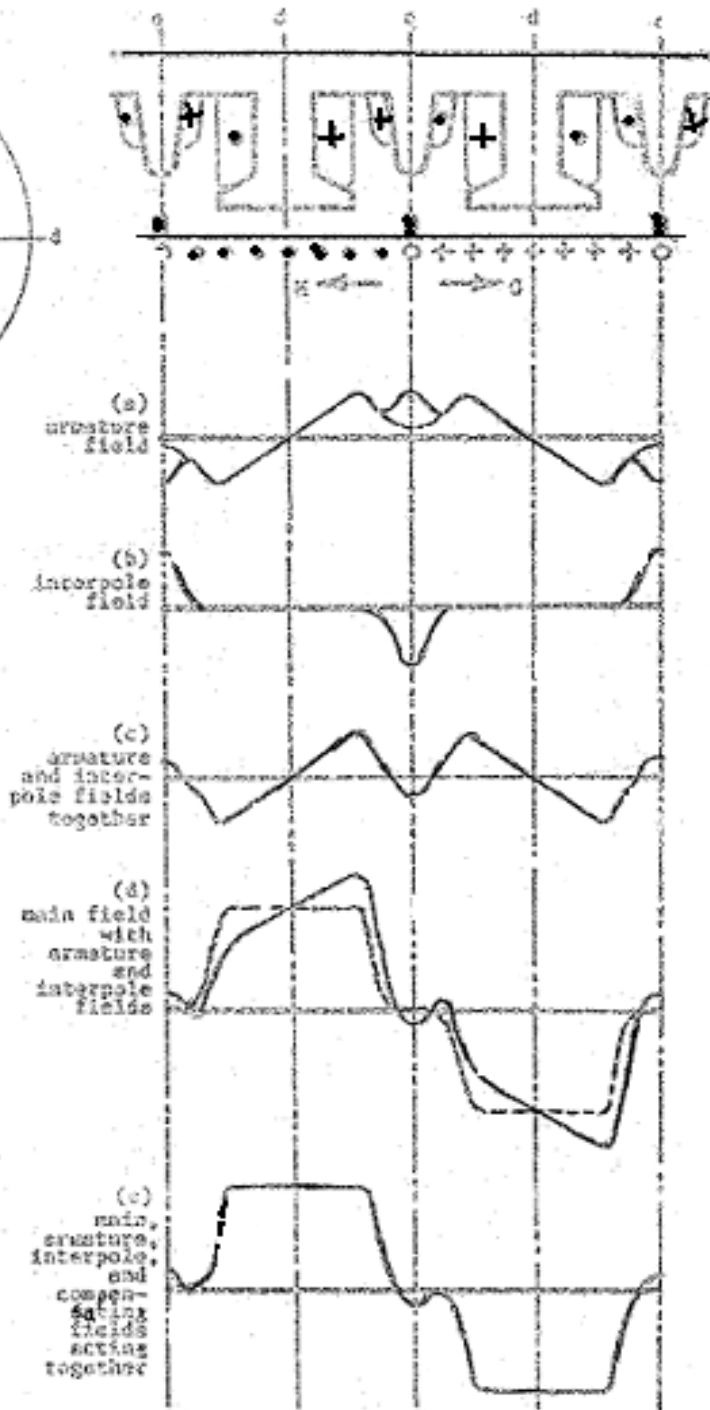

Fig. 6.11 Connection diagram of dc machine.

## 6.6 Brush shift

A second method for improving commutation to limit sparking is to shift the brushes from the q-axis . The principle is as follows:

Recall figs. 5.4 and 5.5 which show how the magnetic neutral axis (mna) moves away from the q-axis due to arm reaction . if now the brushes are shifted in the same direction , they will be in a region where the arm field opposes the main field. At certain location the two fields cancel out; placing the brushes at this location eliminates the rotational emf  $e_c$  (see fig.6.5). This is not enough because there still is the RV . To neutralize RV , the brushes are shifted a little further in the same direction; the sides of commutating coil will then be subjected to a small (but nonzero) field that opposes the coil flux which induces the RV. If the opposing fluxes can be made equal, the RV is eliminated.

As a method for improving commutation, brush shift is not as good as IPs because it has the following disadvantages:

- 1. As the load on the machine changes, the arm current  $I_A$  changes so that AR and the mna shift also change. For correct operation, the brush shift must be changed accordingly, which is impractical. In practice, the brushes are placed in a position that gives minimum sparking at rated load, so that there may be considerable sparking at other loads .
2. From fig. 5.4, it is seen that the mna shifts in the direction of rotation for generator operation, and in the direction opposite to rotation for motor operation. Thus brush shift (which is in the same direction as the mna shift) cannot be used with motors intended to run in both directions, or with machines intended for variable mode of operation: if brush shift is correct for one case , it is incorrect for the other!
3. Brush shift causes demagnetizing armature reaction(see fig. 5.12).

Because of these disadvantages , brush shift is used only in small fractional horsepower machines(rated power less than one hp) where it is not economical to use IPs. Brush shift was also used in old machines before the invention of IPs.

**CHAPTER 7****POWER CONVERSION AND LOSSES**

The input power to the dc machine undergoes electromechanical conversion to produce the output power; the process yields a number of losses that appear as heat which has harmful effects on the performance of the machine.

**7.1 Power balance**

Most of the input power supplied to a dc machine is converted into useful output power; the remainder of the input power is loss and heat. The principle of conversion of energy requires total power balance

$$P_{in} = P_{out} + \text{LOSSES}$$

It is sometimes useful to think of power as 'flowing' through the machine. Power flow is divided into two stages, the border line being the actual electromechanical energy conversion process.

$$P_c = E_A I_A = \omega_r T_d$$

It is also called the internal power because it is defined within the machine; in contrast,  $P_{in}$  and  $P_{out}$  are external powers that can be measured.  $E_A$  and  $T_d$  are internal quantities that cannot be measured directly.

$$P_{in} = P_c + \text{LOSS1} \quad \text{and} \quad P_c = P_{out} + \text{LOSS2}$$

The total loss is made up of 2 parts: LOSS1 occurs before conversion, and LOSS2 occurs after conversion. Clearly

$$P_{in} > P_c > P_{out}$$

**Motor operation**

The input power is electrical, and the output power is mechanical. Part of the input power is lost as electrical(copper) losses in the windings, and the remainder is available for electromechanical energy conversion; part of the converted power is lost supplying the losses due to rotation, and the remainder is available as a mechanical output power to drive the load. Note that

$$P_{\text{mech}} < P_c \gggg \omega_r T_L < \omega_r T_d \gggg T_L < T_d$$

That is, the shaft torque available at the load,  $T_L$ , is less than the developed torque  $T_d$ ; the difference is needed to overcome opposing torques within the motor (such as bearing friction).

### **Generator operation**

The input power is mechanical, and the output power is electrical. Part of the input is lost as rotational losses, and the remainder is available for electromechanical energy conversion; part of the converted power  $P_c$  is lost as electrical (copper) losses in the windings, and the remainder is available as electrical output power to supply the load. Note that

$$P_{\text{mech}} > P_c \gggg \omega_r T_{\text{pm}} > \omega_r T_d \gggg T_{\text{pm}} > T_d$$

That is, the shaft torque produced by the prime mover,  $T_{\text{pm}}$ , is greater than the developed torque  $T_d$ ; the difference is the torque needed to overcome friction and other opposing torques.

### **7.2 Losses**

The losses of a dc machine are of various types and occur in different parts of the machine. Although different losses are produced differently, they all appear as heat, i.e. they represent conversion to useless thermal energy. The heat generated by the losses has two major effects:

- (i) Losses raise the temperature inside the machine, and thus affect the performance and life of the materials of the machine, particularly insulation. Therefore losses determine the upper limits on machine rating.
- (ii) Losses are a waste of energy, and energy costs money; therefore losses result in a waste of money (in the operating cost of the machine).

Losses cannot be eliminated, but they can be reduced by proper design; the design must also provide for ventilation to disperse the heat generated. Thus losses have a significant effect on the initial cost of the machine.

The cost of wasted energy in item(ii) above is important with industrial motors where the powers involved are quite high; it is not important with small control motors where the powers involved are very small. However, the temperature rise in item (i) is important for all motors.

### **Electrical losses**

Electrical losses are also called copper losses, winding losses,  $I^2R$  losses, and ohmic losses. copper losses occur in all windings due to flow of current through them; they are

$$\text{LOSS}_{\text{arm}} = I_A^2 R_A = \text{armature circuit copper loss}$$

$$\text{LOSS}_{\text{ser}} = I_S^2 R_S = \text{series field winding copper loss}$$

$$\text{LOSS}_{\text{sh}} = I_f^2 R_f = \text{shunt field winding copper loss}$$

In computing  $\text{LOSS}_{\text{arm}}$ ,  $R_A$  includes the resistances of commutating and compensating windings (if present). The series field current  $I_S$  may or may not be equal to the armature current  $I_A$ .

The copper loss in a given wdg is proportional to the square of the current in that wdg; if the current is doubled, the copper loss increases four times.  $\text{LOSS}_{\text{arm}}$  and  $\text{LOSS}_{\text{ser}}$  depend on armature current, and hence they depend on the load on the machine ( $I_A$  increases with load).  $\text{LOSS}_{\text{sh}}$  depends on the terminal voltage, and varies with its square.

The above expressions can be used to calculate copper losses using measured values of winding resistances. The wdg resistance must be at the correct wdg temperature; if the temperature at which the loss is required is not known, it is assumed to be  $75^\circ\text{C}$ . if the wdg resistance is known (say by measurement) at a temperature  $T_1$ , it can be found at a different temperature  $T_2$  from

$$\frac{R_2}{R_1} = \frac{T_2 + 234.5}{T_1 + 234.5}$$

The brush contact loss is also an electrical loss. Since the brush contact drop  $V_b$  is approximately constant over a wide range of armature currents, the loss is proportional to the armature current itself (and not its square as in wdg losses):

$$\text{LOSS}_{\text{contact}} = I_A V_b$$

### **Magnetic losses**

Magnetic losses are also called iron losses or core losses. They result from hysteresis and eddy currents in cores subjected to varying magnetization, i.e. mainly in the armature teeth and core, but also in the pole shoes (due to armature slotting).

Iron losses are distributed in the cores in complicated patterns, so that there are no simple formulae that give their values accurately. It is known, however, that iron losses depend on

the magnetization level(flux density) in the cores, and on the frequency with which it alternates,  $f=pn$ .

For the hysteresis loss, we have

$$\text{LOSS}_{\text{hyst}} \propto f B_{\text{max}}^x$$

Where the constant of proportionality is determined by the volume of the core and its magnetic characteristic(hysteresis loop). The Steinmetz exponent  $x$  depends on the type of iron used, and ranges from 1.5 to 2.5 (usually around 2); it is an empirical constant (obtained from experience and testing, not from electromagnetic theory). For the eddy current loss, we have

$$\text{LOSS}_{\text{eddy}} \propto f^2 B_{\text{max}}^2 (\text{lamination thickness})^2$$

Where the constant of proportionality is determined by the volume of the core and its electrical characteristics(resistivity). Clearly, thin laminations reduce eddy current losses. The armature is always laminated, and the pole shoes are usually laminated. If a motor is to be driven from a modern solid-state controlled rectifier, all cores must be laminated(including poles and yoke).

### **Mechanical losses**

Mechanical losses arise from friction and windage(friction with air) during rotation. They depend on the speed of rotation, each type of mechanical loss being proportional to some power of  $n$ . Bearing friction loss depends on the type of bearing used and on the viscosity of the lubricant; improper lubrication (too little or too much) increase the loss.

Brush friction loss is proportional to the area of contact and to the brush pressure; it also depends on the brush and commutator materials, their state of polish, and the temperature at the contact surface; it is often the largest friction loss. Windage losses arise from moving the air around the armature(air friction); they depend on the shape of the rotating surface (smooth or rough). Ventilation loss is an additional windage loss due to fans and vent ducts used to cool the machine.

### **Stray load loss**

Stray load losses are additional losses that occur in the machine when loaded, and cannot be included with the conventional losses listed above. They include:

-additional core loss resulting from armature reaction distortion;



-copper loss due to short circuit current during commutation(in commutating coils, commutator segments, and brushes);

-non uniform current distribution in large armature conductors.

Stray load losses are small and difficult to calculate. They may be neglected for small machines, and are usually assumed 1% of output for large machines.

### 7.3 Classification of losses

Table 7.1 Classification of losses in dc machines.

Loss	type	rotational	With load	dependence
Armature circuit copper loss	elect	No	variable	$\alpha I_A^2$
Series field copper loss	elect	No	variable	$\alpha I_A^2$
Shunt field copper loss	elect	No	constant	$\alpha V_t^2$
Brush contact loss	elect	No	variable	$\alpha I_a$
Hysteresis loss	mag	Yes	constant	$\alpha f B_{\max}^x$
Eddy current loss	mag	Yes	constant	$\alpha f^2 B_{\max}^2$
Friction loss	mech	Yes	constant	$\alpha$ power of n
Windage loss	mech	Yes	constant	$\alpha$ power of n
Stray load loss	Elect&mech	Yes	variable	indeterminate

Table 7.2 Typical values of dc machine losses for industrial motors in the range 1-100 KW; lower percentage losses are for the higher rated motors.

losses	Percent of rated power
Armature cct electrical loss	3---6%
Shunt field electrical loss	1---5%
Rotational losses	3---15%

Table 7.3 Typical efficiencies of industrial motors.

Rated power KW	efficiency
1	75%
50	90%
500	94%
5000	97%

### Constant and variable losses

Constant losses are losses that do not change as the load on the machine changes; they are independent of armature current, and include mechanical losses, core losses, and shunt field winding loss. Variable losses are losses that increase as the load on the machine increases; they are electrical losses including armature circuit copper loss, series field loss, and brush contact loss. Copper losses increase with  $I_A^2$ , while brush contact loss increase with  $I_A$  itself. We may therefore write

$$\text{LOSSES}_{\text{total}} = K_0 + K_1 I_A + K_2 I_A^2$$

The first term on the RHS represents constant losses, while the second and third terms represent variable losses. At full load, constant losses are 4-20%, and variable losses are 3-6 %; see table 7.2.

### Remark

Stray load losses are indeterminate functions of armature current and speed. They complicate classification, but are small enough to be neglected in most cases.

### 7.4 Measurement of losses

There are a number of practical tests to measure the various machine losses. In most cases, a given test yields the sum of two or more losses together; sometimes the component losses can be separated by further testing.

In testing, it is quite easy to measure electrical quantities (resistance, voltage, and current) and speed, somewhat difficult to measure torque, and quite difficult to measure magnetic quantities (flux and flux density). Powers are determined, on the electrical side, by the product of voltage and current, and on the mechanical side by the product of torque and angular speed.

In a load test, the machine is loaded at a given speed and field excitation (i.e. field current); the input and output powers are measured. The total loss at that speed, excitation, and load can be obtained from

$$\text{LOSSES}_{\text{total}} = P_{\text{in}} - P_{\text{out}}$$

The total loss can be separated into electrical and rotational losses by calculating  $I^2R$  products in the various windings using wdg currents measured during the load test and (hot) wdg resistances measured previously. With the electrical losses thus calculated, the rotational losses are obtained from

$$\text{LOSS}_{\text{rotational}} = \text{LOSSES}_{\text{total}} - \text{LOSS}_{\text{elec}}$$

Load tests for large machines are impractical in test labs: they require very large loads, and waste large amounts of energy. There are other tests that yield the losses individually.

In a no load test, the machine is driven by a suitable prime mover (possibly another machine) with its terminals open circuited (i.e. it operates as unloaded generator). The input power to the test machine is measured mechanically (torque and speed), or electrically by measuring the input power to the drive motor and subtracting its losses (which must therefore be known). If the test machine is unexcited then  $P_{\text{in}} = \text{LOSS}_{\text{mech}}$ . If the test machine is then excited but left unloaded we get  $P_{\text{in}} = \text{LOSS}_{\text{rot}}$ ; the core loss is obtained from

$$\text{LOSS}_{\text{core}} = \text{LOSS}_{\text{rot}} - \text{LOSS}_{\text{mech}}$$

(Exercise: suggest a test for separating the brush friction loss).

If no suitable drive (prime mover) is available, rotational losses may be obtained by running the machine as a motor with no external load; this is the running light test, or Swinburne test.

The input power will mainly go to rotational losses, but there will also be a little copper loss (why?). The copper loss may be computed and subtracted from the input power to yield rotational losses. In the running light test, rotational losses cannot be separated into mechanical and core losses (why?).

As seen from the above tests, it is always possible to determine copper losses from the measured values of wdg currents during the tests, and previously measured wdg resistances. Winding resistances are measured by standard methods (voltmeter-ammeter, Wheatstone bridge, etc.); the wdg temperatures must be monitored at the time of resistance measurement (why?), or the measurement is made with the machine hot (for example directly after a load test).

The no load and running light tests determine machine losses without loading it. Other tests have been devised to operate the machine at full load conditions without requiring an external load.

An example of such tests is the opposition test (Kapp-Hopkinson test) which requires two identical machines. The machines are coupled mechanically, and connected in parallel with each other to the mains. By increasing the excitation for one machine and decreasing it for the other, the first will operate as a generator, and the second as a motor: the generator supplies the motor electrically, while the motor drives the generator mechanically; the power input from the mains supplies the losses to keep the system running. By suitable adjustments of the field rheostats, the armature currents can be set to their rated values. With the two machines running at or near rating (current, voltage, and speed), they will develop full load losses, yet the disadvantages of a load test have been avoided: no external load is needed, and the mains supplies only machine losses, not their full power.

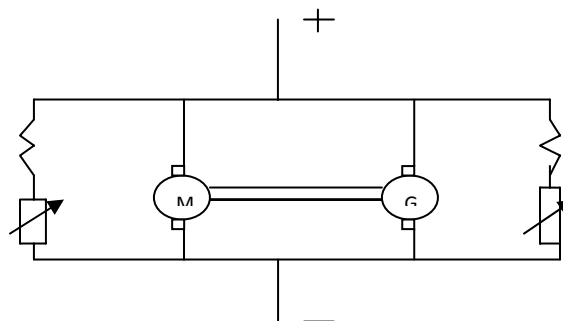

In a heat run (or temperature-rise test), the machine is run at full load to develop full-load losses; the test takes 20-60 minutes until the temperature reaches steady state corresponding to its rated operating value. The no load and running light tests cannot replace the load test in a heat run because they do not generate all machine losses simultaneously. An opposition test, on the other hand, can be used in a heat run.

### 7.5 Efficiency

The efficiency of a machine is defined by

$$\eta = \frac{P_{out}}{P_{in}} = \frac{P_{out}}{P_{out} + \text{LOSSES}} = 1 - \frac{\text{LOSSES}}{P_{in}}$$

The first expression is general, the second is suitable for generators ( $P_{out}$  measured electrically), and the third is suitable for motors ( $P_{in}$  measured electrically). The efficiency is a fraction less than unity, and is usually expressed in percent. Table 7.3 lists typical values of dc machine efficiencies.

The general definition of efficiency given above can be analyzed into two component efficiencies corresponding to the two stages of power flow:

$$\eta = \frac{P_{out}}{P_{in}} = \frac{P_c}{P_{in}} \frac{P_{out}}{P_c}$$

For a motor, this becomes

$$\eta = \frac{P_c}{P_{elec}} \frac{P_{mech}}{P_c} = (\text{eff of conversion})(\text{mech eff})$$

and for a generator, it becomes

$$\eta = \frac{P_c}{P_{mech}} \frac{P_{elec}}{P_c} = (\text{eff of conversion})(\text{elec eff})$$

#### maximum efficiency

we have already divided losses into constant and variable ; the efficiency was then expressed as in the eq. given in page 74. Now consider motor operation: neglecting the small shunt field current, the input power is

$$P_{in} = V_t I_A$$

$$\text{Using } \eta = 1 - \frac{\text{LOSSES}}{P_{in}} = 1 - \frac{K_o + K_1 I_A + K_2 I_A^2}{V_t I_A}$$

$$\eta = 1 - \frac{1}{V_t} (K_o I_A^{-1} + K_1 + K_2 I_A)$$

This gives efficiency as a function of armature current  $I_A$ ; to locate the point of maximum efficiency, we differentiate the above eq. w.r.t  $I_A$ , and to find the maximum efficiency point, we equate the differential to zero:

$$\frac{d\eta}{dI_A} = -\frac{1}{V_t} (-K_o I_A^{-2} + K_2)$$

And equate to zero, we get

$$K_2 I_A^2 = K_o$$

Thus maximum efficiency occurs when the copper losses  $K_2 I_A^2$  equal the constant losses  $K_o$

(or, as an approximation, when variable losses equal constant losses- i.e. assuming the brush contact loss  $K_1 I_A$  is small). Industrial machines are usually designed to have maximum efficiency for  $I_A$  between half and full load values (because the machine operates at less than full load most of the time); the exact choice is not critical because the efficiency curve is flat around the maximum value.

For industrial motors, traction motors, and other power-application motors, efficiency is quite important, but it is only one of a number of factors that determine how good a machine is; the other factors include power/weight ratio, power/cost ratio, reliability, maintenance requirements, vibration and noise, etc. For small control motors, efficiency is of little importance; the main factors of interest include accuracy, cost, size, speed of response, reliability, noise, weight, interference, etc.

## **Chapter 8**

## **GENERATOR OPERATION**

In generator operation, a dc machine is driven by a prime mover and supplies an electrical load. We will explain the operating characteristics of dc generators and the factors that affect them.

### **8.1 The voltage equation**

In generator operation, we are interested in the voltage supplied at the output terminals. From KVL and the information of the previous chapters, the terminal voltage of a dc generator can be written as follows:

$$V = E_A - (\Sigma IR + V_b)$$

$$= K_e \cdot n \cdot \phi_r - (\Sigma IR + V_b)$$

$$= E_{Aoc} - (\Sigma IR + V_b + \Delta E)$$

$$= K_e \cdot n \cdot \phi_m - (\Sigma IR + V_b + \Delta E)$$

Where  $E_A = K_e \cdot n \cdot \phi_r$  is the induced emf in the armature, and  $\phi_r$  is the actual (i.e. resultant) flux per pole;  $E_{Aoc} = K_e \cdot n \cdot \phi_m$  is the induced emf on open circuit (no armature current), and  $\phi_m$  is the flux per pole due to the main field.  $\phi_r$  may be somewhat less than  $\phi_m$  due to the demagnetizing effect of armature reaction;  $\Delta E$  represents the corresponding reduction in induced emf ( $\Delta E = E_{Aoc} - E_A$ ). The difference between the induced emf  $E_A$  and the terminal voltage  $V$  is the sum of series resistive drops  $\Sigma IR$  (in the armature, series field wdg, commutating wdg, and compensating wdg) and the brush contact drop  $V_b$ . This equation tells us that the terminal voltage is determined primarily by the speed  $n$  and the main field flux  $\phi_m$ , with some reduction due to series voltage drops and armature reaction.

### Speed of rotation

The speed is set at the prime mover, not the generator itself. Of course the generator is a mechanical load on the prime mover, and hence affects its operation: as the electrical load on the generator increases, the armature current  $I_A$  increases thus increasing the developed torque  $T_d (= K \cdot I_A \cdot \phi_r)$ ; if the prime mover torque does not increase to balance the increase in  $T_d$ , it will slow down (reducing  $E_A$ , hence  $I_A$ , hence  $T_d$ ). However, in many applications, the prime mover is equipped with automatic control that maintains the speed almost constant.

### Field excitation

The main flux  $\phi_m$  is determined by the field mmf through the magnetization curve, or we say that  $E_{Aoc}$  is determined by the field excitation current through the OCC. The shunt field excitation may be controlled by means of variable resistance in series with the shunt field wdg, and the series field excitation may be controlled by means of a small variable resistor (diverter) in parallel with the series field wdg.

### Voltage drops

The series resistive drops  $\Sigma IR$  and the armature reaction drop  $\Delta E$  increase with load (why?); the brush contact drop  $V_b$  is practically constant over the normal working range of  $I_A$ . The total drop is generally small (small wdg resistances, and small demagnetizing effect of armature reaction). For simplicity, we shall use the symbol  $\Delta V$  for the total drop

$$\Delta V = \Sigma IR + V_b + \Delta E$$

$$\text{Then } V = E_{Aoc} - \Delta V = K_e \cdot n \cdot \phi_m$$

## 8.2 Definitions

We shall need the terms and concepts defined below in our description of generator operation and the factors that affect it.

### External characteristic

The external characteristic of a dc generator is the curve relating terminal voltage  $V$  and terminal current  $I$  (i.e. load current). The curve shows how voltage changes with load. For a simple source circuit composed of constant emf in series with constant internal resistance, the external characteristic is a straight line with negative slope.

The external characteristic of a dc generator will be different from the simple source circuit, not only because of the additional drops  $V_B$  and  $\Delta E$ , but also because  $\phi_m$  itself may change with load (if for example the generator has a series field).

The operating point (for a given voltage  $V$  and a given current  $I$ ) may also be found graphically by drawing  $V$ - $I$  characteristic of the load, and intersecting it with the external characteristic of the source; the intersection is the point that satisfies both characteristics at the same time.

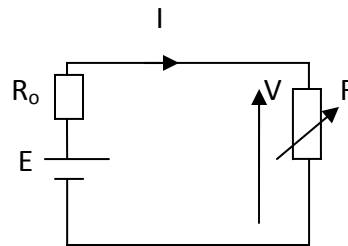
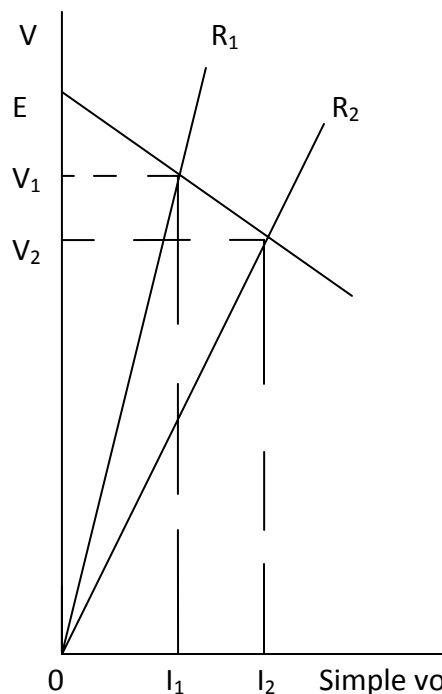

Simple voltage source :external characteristic and circuit diagram

For the typical drooping characteristic shown, it is seen that decreasing the load resistance increases the load current and decreases the terminal voltage ( $R_2 < R_1$ ,  $I_2 > I_1$ , and  $V_2 < V_1$ ).

**Remark 1 :** The graphical method can be used even when the external characteristic and the load  $V$ - $I$  characteristic are nonlinear (not straight lines).



**Remark 2 :** The internal characteristic is the curve relating the emf and current. It is a horizontal line at  $E$  for the simple source circuit given above, but can be different in generators.

Voltage control

A given external characteristic corresponds to a fixed speed and fixed settings of the field control resistors. If the settings of the field resistors are changed,  $\phi_m$  will also change (since the excitation currents are changed), and operation shifts to another curve.

Therefore the operating point may be moved from one curve to another by changing the field excitation, as shown in the fig. below. The terminal voltage may be kept approximately constant by automatic regulators that sense the terminal voltage and increase or decrease the excitation to keep the voltage at the set value.

Voltage regulation

The voltage regulation of a generator at a given load is defined by

$$\text{Voltage regulation} = \frac{\text{no load voltage} - \text{load voltage}}{\text{load voltage}}$$

It is a figure of merit that indicates how constant the terminal voltage is with load; a good voltage source should have small voltage regulation. The voltage regulation of generators equipped with automatic voltage control is almost zero.

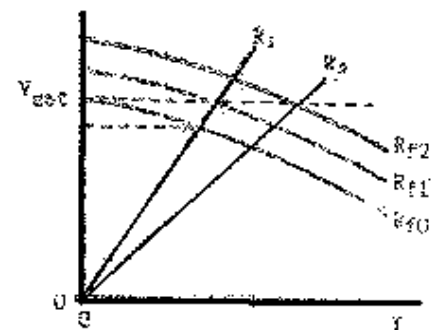

**8.3 Separately excited generator**

If the field current of a separately excited generator is kept constant,  $\phi_m$  and  $E_{Aoc}$  will be constant. The external characteristic is then as shown in fig. 8.5 :  $V$  is less than  $E_{Aoc}$  due to the armature circuit resistive drop  $I_A R_A$  (linear with current), the demagnetizing effect of armature reaction  $\Delta E$  (nonlinear function of  $I_A$ ), and the brush contact drop  $V_b$  (constant-not shown in the figure). The

curvature of the characteristic comes from  $\Delta E$ . Compare with the simple source given above.

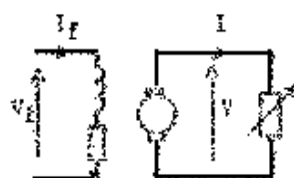
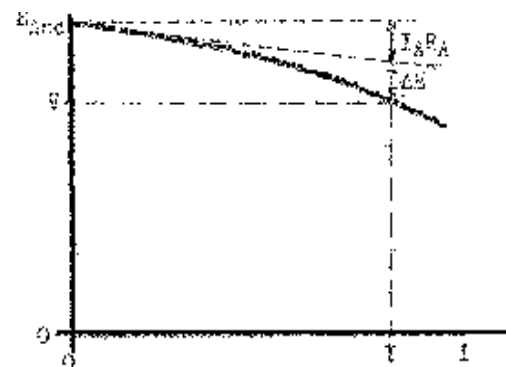

Fig. 8.5



### 8.4 Shunt generator

The external characteristic of the shunt generator, fig 8.6 , is similar to that of the separately excited generator, but has an additional drop due to shunt field weakening:

$$I_A \uparrow \rightarrow \Delta V \uparrow \rightarrow V \downarrow \rightarrow I_f \downarrow \rightarrow \phi_m \downarrow \rightarrow E_{Aoc} \downarrow$$

To explain this process in more detail, we first draw the OCC as in fig 8.7 ; note that the OCC is obtained with the shunt field wdg disconnected from the armature and fed from a separate source. Next we draw the V-I characteristic for the shunt field resistance

$$V = R_f I_f$$

On the same graph. Now, for any field current  $I_f$ , the point  $(I_f, E_{Aoc})$  must lie on the OCC, and the point  $(I_f, V)$  must lie on the  $R_f$ -line. At no-load the terminal current  $I$  is zero so that  $I_A$  is equal to  $I_f$  which is small, so that we may neglect the drop  $\Delta V$  ; thus the terminal voltage  $V$  is equal to the induced emf  $E_{Aoc}$  . This condition is satisfied only at the point of intersection of the  $R_f$ -line with the OCC; therefore, at no-load, we have

$$I_f = I_{f0}, E_{Aoc} = E_o, V = V_o, \text{ with } V_o = E_o$$

Consider next the generator on load.  $I_A$  has increased so that the drop  $\Delta V$  is now large enough to make  $V$  less than  $E_{Aoc}$  . operation has to shift from the point of intersection:

$(I_f, E_{Aoc})$  moves down the OCC, while  $(I_f, V)$  moves down the  $R_f$ -line .  $I_f$  will take up a position at which the difference between  $E_{Aoc}$  and  $V$  is equal to the drop  $\Delta V$  :

$$I_f = I_{f1}, E_{Aoc} = E_1, V = V_1, \text{ with } V_1 = E_1 - \Delta V_1$$

Comparing  $V_1$  and  $V_o$  , we see that the difference between them is the drop  $\Delta V_1$  plus an additional drop  $(E_o - E_1)$  due to the reduction of the induced emf  $E_{Aoc}$  from  $E_o$  to  $E_1$  corresponding to the reduction of the field current  $I_f$  from  $I_{f0}$  to  $I_{f1}$  – as was stated at the beginning of this section.

At each value of load current  $I$ , the field current  $I_f$  moves to a position that makes the difference between the OCC and the  $R_f$ -line equal to the drop  $\Delta V$  that corresponds to that load current or, more precisely, to the armature current  $I_A$  . If you study the OCC and the

$R_f$ -line carefully, you will see that there is a certain  $I_f$  at which the difference between them is maximum. therefore there is a maximum armature current and hence a maximum load current,  $I_{max}$  in fig. 8.6 this is called the breakdown point.

The short circuit current of the shunt generator is inherently limited: at SC the terminal voltage  $V$  is zero so that  $I_f = 0$ ; the emf is  $E_{res}$  (induced by the residual flux alone) which is very small. The resulting armature current is therefore small.

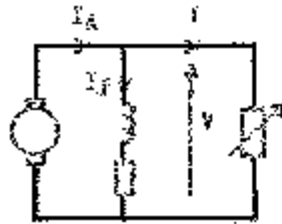

Fig. 8.4 shunt generator connection diagram and external characteristic

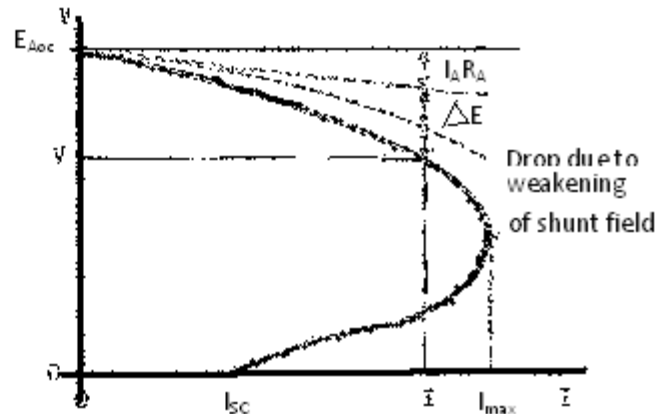

Fig. 8.7 open circuit characteristic and field resistance line for shunt generator.

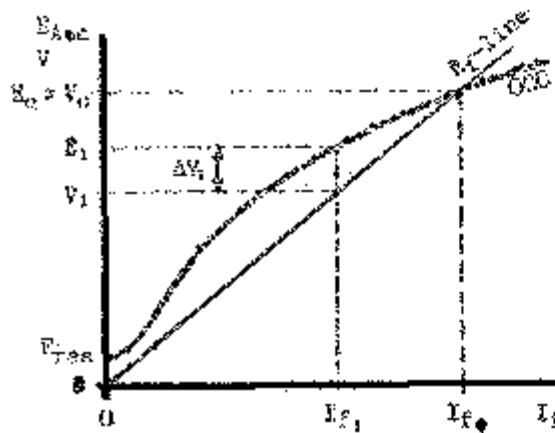

Fig.8.8 effect of field resistance on voltage build-up in shunt generator.

on voltage build-up in shunt generator generator.

Voltage build-up

The preceding discussion helps us understand how the voltage of the shunt generator builds up. Assume that there is no load on the generator, and that there is an open switch in the field circuit so that  $I_f = 0$ ,  $E_{AOC} = E_{res}$ , and  $I_A = 0$ . If the switch is now closed,  $E_{res}$  is applied to  $R_f$ , and a small current  $I_f$  flows causing  $E_{AOC}$  to climb up the OCC. But this increased value of  $E_{AOC}$  is again applied to  $R_f$  and will increase  $I_f$ , which in turn increases  $E_{AOC}$  some more. The process continues with  $(I_f, E_{AOC})$  climbing up the OCC and  $(I_f, V)$  climbing up the  $R_f$ -line until the two points coincide at the intersection point. We say that the shunt generator voltage  $V$  has 'built up' to  $V_0$ ; what stops the build-up process from continuing indefinitely is the curvature of the OCC, i.e. saturation. (Exercise: how does KVL apply to the circuit during build-up?).

The process of voltage build-up requires the following conditions to succeed:

- (1) There must be residual flux to start the process. A new generator, or one that has not been used for long time, must be magnetized first. This is done by applying a separate dc source (for example a battery) to the field wdg for a short time; it is called 'flashing the field'.
- (2) The flux produced by  $I_f$  should aid the residual flux. If the field wdg is connected in the reverse direction, the voltage will 'build-down', i.e. it becomes less than  $E_{res}$  (i.e. almost zero).
- (3) The resistance of the field circuit should be small enough to intersect the OCC in the saturation region. As  $R_f$  is made larger, the intersection moves down the OCC, fig. 8.8. The field resistance line that is tangent to the linear part of the OCC is called the critical field resistance,  $R_{crit}$  in fig. 8.8: if  $R_f$  is increased further, there will be no build-up. The critical resistance is higher for higher speeds (why?); the critical speed corresponding to a given field resistance is the speed at which the linear part of the OCC becomes tangent to that resistance line. If the shunt generator fails to build-up at a certain speed due to large field resistance, it might build-up at a higher speed.
- (4) Proper relationship between direction of field connection and direction of armature rotation.

### 8.5 Compound generator

A compound generator is essentially a shunt generator with additional mmf from the series wdg :

$$\text{MMF}_{\text{total}} = N_f I_f \pm N_s I_s$$

The compounding is cumulative if the series field aids the shunt field (plus sign); the compounding is differential if the series field opposes the shunt field (minus sign). For long shunt connection,  $I_s = I_A$ , and for short shunt connection  $I_s = I_A - I_f \cong I_A$ . If a diverter is used,  $I_s$  may be less than these values.

The OCC of a compound machine corresponds to separate excitation of shunt field alone. Dividing the above eqn. by the shunt field turns

$$\frac{\text{MMF}_{\text{total}}}{N_f} = I_f \pm \frac{N_s}{N_f} I_s = I_{eq}$$

The term  $\frac{N_s}{N_f} I_s$  is the series field excitation referred to the shunt field circuit;  $I_{eq}$  represents total excitation in terms of shunt field amperes, and can be read off or projected directly on the horizontal axis of the OCC.

### Cumulative compounding

As seen in section 8.4 the terminal voltage of a shunt generator drops due to  $\Delta V$  and the reduction in  $E_{Aoc}$ . In a cumulative compound generator, the series field compensates for part or all of the drop. The series field current changes with load (why?) so that the degree of compensation changes with load. The number of series turns  $N_s$  may be chosen such that the resulting series field compensates exactly for the drop at full load; the full load voltage is then equal to the no-load voltage (zero voltage regulation), and the machine is said to be flat-compounded (or level-compounded)-see fig 8.9. If fewer series turns are used, we have under-compounding: the full load voltage is less than the no-load voltage (positive regulation), but still more than the shunt generator full load voltage. If more series turns are used, we have over-compounding: the full load voltage is greater than the no load voltage (negative regulation). It is also possible to choose  $N_s$  for over-compounding, and change the actual degree of compounding by means of a diverter (a variable resistor connected shunt with series field winding).

### Differential compounding

When the series field opposes the shunt field, it effectively increases the drops. The external characteristic is then below that of the shunt generator, fig.8.9.

### **8.6 Series generator**

The OCC for a series generator, fig.8.10, is obtained with the field supplied from a separate source (the armature is open circuited by definition). In normal operation, the field wdg is connected in series with the armature, and the terminal voltage  $V$  is less than the induced emf  $E_{Aoc}$  due to the drop  $\Delta V$ ; the external characteristic is thus below the OCC as shown in fig. 8.10. The rising part of the curve is not stable: a slight change of load resistance causes large changes in terminal voltage and current. In the saturation region, the OCC is almost horizontal, but  $\Delta V$  continues to increase with  $I_A$  so that the curve is falling; the fall is sharp in series generators designed to have strong demagnetizing armature reaction.

### **8.7 Applications**

For dc power generation, the separately excited generator has acceptable voltage regulation, but has the disadvantage of requiring a separate source. The self-excited shunt generator does not require a separate source, but has poor regulation. The cumulative compound generator overcomes this problem; it can be designed to have zero regulation by suitable compounding. Modern generators are equipped with automatic voltage control, possibly solid-state, so that they have excellent regulation; the design of the control system is determined by the external characteristic of the

generator. However, solid-state rectifiers are rapidly replacing dc generators in most applications; technological advances have made it possible to manufacture commercial solid-state components of high rating, i.e. components capable of passing high currents and withstanding high voltages. For example, the dc generator in the automobile has been replaced by an ac generator(alternator) with rectifier.

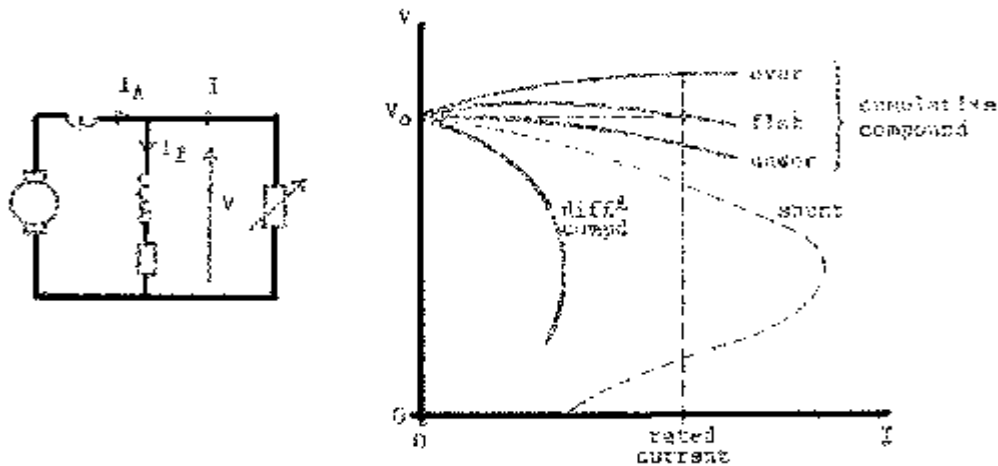

Fig. 8.9

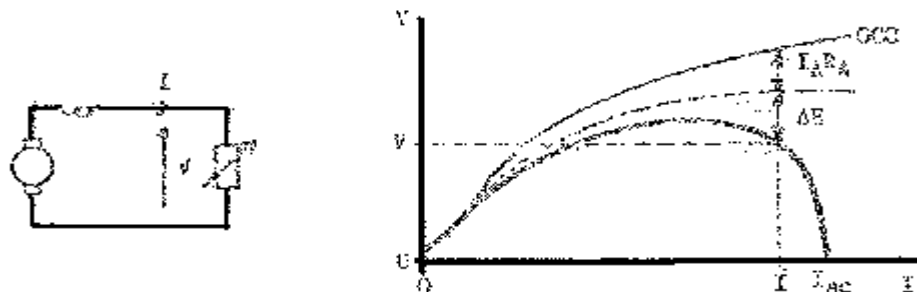

Fig. 8.10

The external characteristics of the series and differential compound generators make them unsuitable for dc power generation at constant voltage. The falling portions of their characteristics correspond to constant current operation over that range. The series generator has been used as a booster: it is connected in series with the line between a generator and its load; its rising characteristic compensates for the drop in the line.

### 8.8 Parallel operation

Two dc generators, a generator and dc power mains, or a generator and a battery, may be operated in parallel to supply a common load. The over-all characteristic is obtained by graphical parallel addition of their external characteristics, fig. 8.11. The figure also shows how the two generators share the load current according to their individual characteristics.

When we intend to operate two generators in parallel, before closing the paralleling switch we must make sure that the voltages of the two generators are equal and have the same polarity; otherwise large currents may circulate between them.

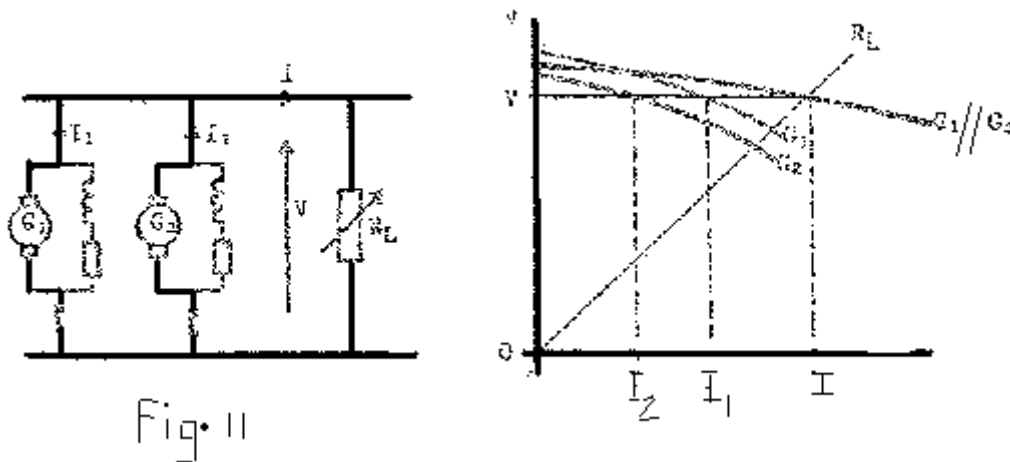

## Chapter 9

### MOTOR OPERATION

In motor operation, a dc machine is supplied electrically, and drives a mechanical load.

#### 9.1 Governing equations

In motor operation, we are interested in the output torque and shaft speed, and their influence on the current drawn by the motor. From previous chapters, the emf and torque equations for a dc machine are

$$E_A = K_e \cdot n \cdot \phi$$

And

$$T_d = K_t \cdot I_A \cdot \phi$$

$\phi$  in these equations is the resultant useful flux per pole, i.e. it includes any demagnetization due to armature reaction. From KVL, we have

$$E_A = V - (\Sigma IR + V_b)$$

$V$  is the voltage applied to the motor terminals, and  $\Sigma IR$  is the total series resistive drop (arm wdg, commutating wdg, compensating wdg, series field wdg, and any additional series resistance). To simplify our study, we shall approximate this equation to

$$E_A = V - I_A R$$

i.e the brush voltage drop is ignored, and  $R$  includes all resistances in the path of the armature current. Dividing the above eqn. by  $K_e \phi$ , we get

$$n = \frac{V - I_A R}{K_e \phi}$$

This equation tells us that speed is determined primarily by the applied voltage  $V$  and the flux  $\phi$ , with some reduction due to the series voltage drop  $I_A R$  (which depends on current, and hence on load torque). The above eqn.s allow us to understand motor operation.

#### Load : torque and current

The developed torque  $T_d$  is slightly greater than the load torque  $T_L$  due to rotational losses:

$$T_d = T_L + T_{\text{rot loss}}$$

The greater the load on the motor, the greater the current it draws from the supply. The load torque determines the current of the motor.

Actually, the above eqn. holds only under steady-state conditions, i.e. when the speed is constant. Under transient (or dynamic) conditions, the two sides of the equation are not equal, and the difference between them produces an acceleration

$$J \frac{d\omega_r}{dt} = T_d - (T_L + T_{\text{rot loss}})$$

Where  $J$  is the moment of inertia of the rotating parts (rotor, shaft, and load);  $\frac{d\omega_r}{dt}$  is the angular acceleration. The above eqn. is a development from Newton's law  $F=ma$  (i.e. it relates to the mechanics of the system).

Suppose that the motor is running at some constant speed so that  $\frac{d\omega_r}{dt} = 0$ . Now suppose the load on the motor suddenly increases: the motor will slow down according to the dynamic eqn. above. But this causes the induced emf to decrease. The resulting increase in the difference between  $V$  and  $E_A$  must be balanced by an increase in the armature current  $I_A$ . The increase in current increases the developed torque  $T_d$ , and the initial increase in load torque is thus met. The motor now operates at steady state again, but at a reduced speed.



Note that if the series resistance  $R$  is small, then only a slight change in speed is sufficient to cause large changes in armature current (and hence in developed torque).

After a disturbance (sudden change in load), the time it takes the motor to settle at a new speed is called the response time. It is determined by the electrical time constant of the motor and the mechanical time constants of the motor and connected load. In certain applications, particularly automatic control systems, the response must be quick, and the motor is designed to have low inductance and low inertia.

The series resistance in the armature circuit is small, so that the induced emf  $E_A$  is approximately equal to the applied voltage  $V$ , hence for a given value of flux  $\phi$ , the speed is determined primarily by the applied voltage  $V$ .

The flux  $\phi$  is determined primarily by the main field mmf (i.e. by field current), and may be controlled by field resistors. The torque is directly proportional to flux, but the speed is inversely proportional to it. Thus an increase in flux tends to decrease speed, and a decrease in flux tends to increase speed. Clearly, then, armature reaction tends to increase speed, while the series field in cumulative-compound motors tends to decrease speed.

## 9.2 Definitions

We shall need the terms and concepts defined below in our description of motor operation and the factors that affect it.

### Mechanical characteristics

The mechanical characteristic of a dc motor is the curve relating the motor's two output variables, torque and speed; the curve shows how speed changes with load.

We can rewrite the eqn. of speed as follows:

$$n = \frac{V}{K_e \phi} - \frac{R}{K_e K \phi^2} T_d$$

for constant  $V$  and  $\phi$ , the above eqn. represents a straight line with negative slope, fig. 9.2. The first term on the RHS gives the vertical intercept (no-load speed), and the coefficient of  $T_d$  in the second term gives the slope. The load torque  $T_L$  is a little less than the developed torque  $T_d$ , so that the relationship curves below the straight line. The shape of the curve may be further modified due to changes in the flux  $\phi$  (which affects both slope and intercept) as the motor load changes; the flux changes with load when there is a series field, and when the demagnetizing effect of armature reaction is not negligible.

When the motor is driving a mechanical load, the torque and speed are found from the motor mechanical characteristic and the load torque-speed characteristic, fig.9.2; that is, the operating point  $(T_1, n_1)$  is found graphically. Fig. 9.3 shows some typical characteristics of mechanical loads.

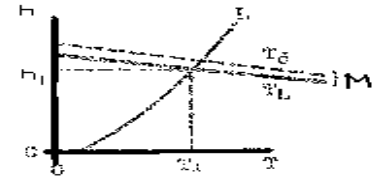
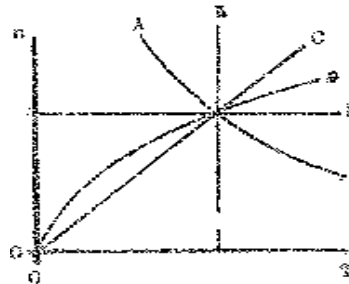

Fig. 9.2

Stability

The operating point may or may not be stable. In fig. 9.4a it is stable: if the speed suddenly increases from  $n$  to  $n'$ , the load torque  $T'_L$  will be greater than the motor torque  $T'_M$ , causing deceleration back to the operating point  $(n,T)$ ; the operating point will also be restored to  $(n,T)$  for a sudden decrease in speed (try it).



- A:  $T \propto 1/n$  (constant power: traction)
- B:  $T = \text{constant}$  (traction, lifts, cranes)
- C:  $T \propto n$  (machine tools)
- D:  $T \propto n^2$  (fans, centrifugal pumps)
- E:  $n = \text{constant}$  (ac alternators)

Fig. 9.3

In fig. 9.4 b, the operating point is unstable: if the speed suddenly increase from  $n$  to  $n'$ , the motor torque  $T'_M$  will be greater than the load torque  $T'_L$ , causing acceleration and further increase in speed away from the operating point  $(n,T)$ ; a sudden decrease in speed may result in stall (zero speed). Clearly, then, the stability of the operating point depends on the relative shapes of the motor and load torque-speed characteristics.

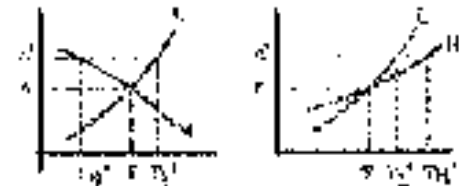

(a) stable

(b) unstable

Fig. 9.4

Speed control

$n = \frac{V - I_A R}{K_e \phi}$  indicates that the speed may be controlled by means of the applied voltage, main flux, and the series resistance; these parameters may be adjusted manually or automatically. Although the armature current  $I_A$  appears in the equation, and hence affects speed, it is not a proper controlling parameter because it cannot be adjusted as desired, but is determined by the mechanical load.

Now a given mechanical characteristic corresponds to a particular setting of the applied voltage, field control resistor, and series resistance. If any of the settings is changed, operation shifts to another curve. Therefore the operating point may be moved from one curve to another by changing the setting of one or more of the control parameters, fig. 9.5. The speed

may be kept approximately constant by automatic regulators that sense the shaft speed and adjust one of the control parameters to keep it at the set value.

### Speed regulation

The speed regulation of a motor at a given load is defined by

$$SR = \frac{\text{no-load speed} - \text{speed under load}}{\text{speed under load}}$$

It is a figure of merit that indicates how constant the shaft speed is with load. For many applications, a good drive motor is one which maintains its speed constant over a wide range of loads. The speed regulation of motors equipped with automatic speed control is almost zero.

A low value of speed regulation is not always desirable. There are applications that require the motor to change its speed with load, for example to keep the torque or output power constant. A main feature of the dc motor is that its operation can be tailored to suit any type of load requirements.

### 9.3 Constant-flux motors (permanent-magnet; separately-excited; shunt)

The difference between shunt and separately excited motors is that the field of a shunt motor is fed from the same source as the armature, while the field of a separately excited motor is fed from a different source, possibly at a different voltage. In both cases, constant field voltage and resistance result in constant field current ( $I_f$  does not change with load), and hence constant main field flux. Permanent magnet motors also operate with a constant main field.

If the demagnetizing effect of armature reaction is neglected, the developed torque  $T_d$  will be directly proportional to the armature current  $I_A$ , so that the two variables are related by the straight line shown dotted in fig. 9.6. Armature reaction may reduce the flux  $\phi$ , and hence reduce  $T_d$ , so that the actual relationship between  $T_d$  and  $I_A$  is curved slightly below the straight line. The load torque  $T_L$  is less than the developed torque due to rotational losses, so that the  $T_L$  curve is slightly below the  $T_d$  curve, fig.9.6. The relationship between torque and current is sometimes called the torque characteristic of the motor.

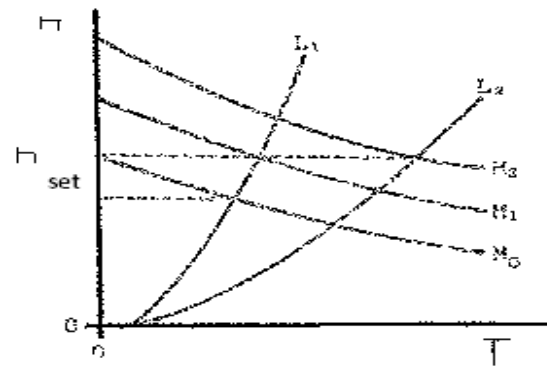

Fig. 9.5

For constant-flux motors, the mechanical characteristic is a straight line with a slight negative slope, fig.9.7. Armature reaction may reduce the useful flux and hence increase the speed, so that the mechanical characteristic curves slightly above the straight line. This upward curvature may lead to instability, it is avoided by designing the motor to have no demagnetizing armature reaction (by the use of interpoles); and by adding a weak series field to compensate for the reduction in flux (stabilized shunt motor).

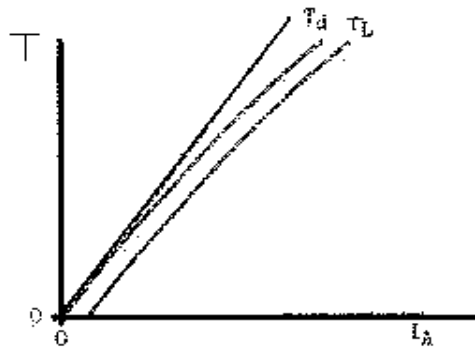

Fig. 9.6

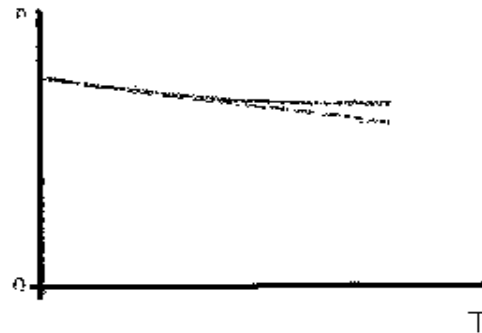

Fig. 9.7

The reduction in speed with load is very small for constant-flux motors. The mechanical characteristic is said to be hard, and the motors operate in an essentially constant speed mode.

#### 9.4 Series motor

The main field flux of the series motor changes with load current according to the OCC; therefore the series motor is characterized by variable flux, as opposed to the constant flux motors. At light loads, operation is on the linear part of the OCC, so that

$$\phi \propto I_A \quad \text{and} \quad T_d \propto I_A^2$$

Thus the torque characteristic follows a parabola at light loads, fig. 9.8. At heavy loads, the machine will be saturated so that the flux is almost constant, and operation approaches that of constant-flux motors

$$\phi \cong \text{constant} \quad \ggggg \quad T_d \propto I_A$$

The torque characteristic approaches a straight line at heavy loads, fig.9.8.

Applying the same reasoning to the mechanical characteristic, we see that

$$\text{At light loads : } n \cong \frac{K_1}{T_d} - K_2$$

$$\text{And at heavy loads : } n \cong K_3 - K_4 T_d \quad (\text{similar to shunt})$$

The mechanical characteristic will then have the general shape shown in fig.9.9 . The change of speed with load is quite large; the mechanical characteristic is said to be soft, and the series motor operates in a variable speed mode. The motor has a high starting torque, but the torque quickly decreases as speed goes up. At no-load the speed becomes so high that it can damage the motor; therefore series motors are never run unloaded, and are always rigidly coupled to their loads(i.e. belts are never used).

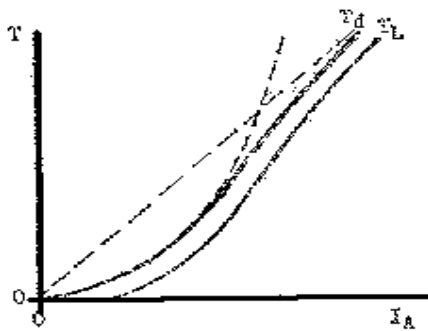

Fig. 9.8

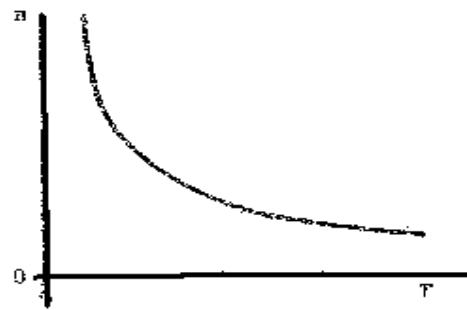

Fig. 9.9

### 9.5 Compound motors

A compound motor has both shunt and series fields. For cumulative compounding, the motor characteristics will move from shunt c/s in the direction of series c/s as load increases(i.e. as the series field becomes stronger); see fig.s. 9.10, 9.11. The actual shape of the mechanical c/s is determined by the degree of compounding, i.e. by the ratio  $\frac{N_s}{N_f}$ , fig. 9.11. Differential compound motors have rising mechanical c/s because of the reduction in main field flux with load.

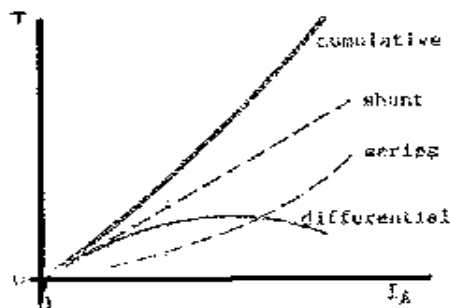

Fig. 9.10

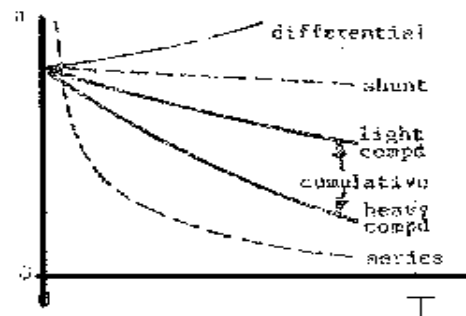

Fig. 9.11

### Armature voltage control

In PM and separately-excited motors, the voltage applied to the motor can be varied with the field remaining constant. Different voltages then give different intercepts (different no-load speeds), and we get a family of parallel (i.e. same slope) mechanical c/s as in fig. 9.12.

Similar downward shifts occur for the series motor, fig.9.13. The simplest method of

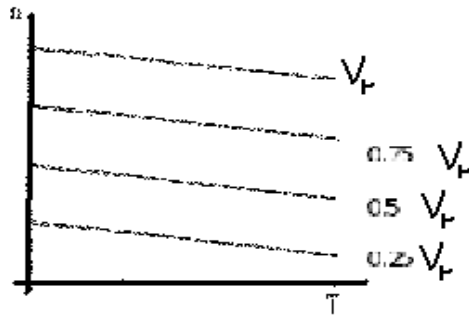

FIG. 9.12

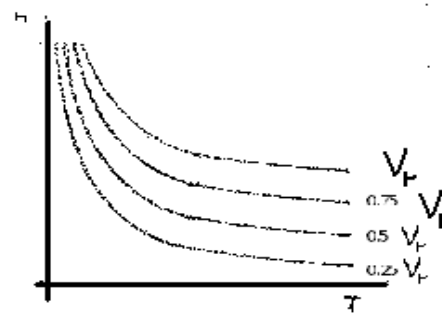

FIG. 9.13

obtaining variable dc voltage is to use a voltage divider, but this method is impractical and uneconomical; it is used only for testing.

In modern applications, variable dc voltage for the armature is often obtained from a solid-state controlled rectifier, with the field fed from an uncontrolled rectifier, fig.9.14. The

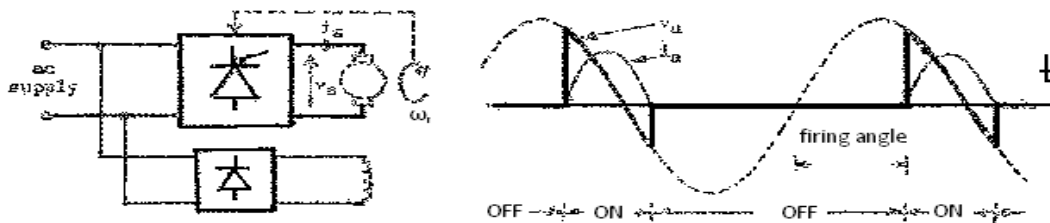

FIG. 9.14

firing angle of the controlled rectifier may be changed manually, but in practice it is adjusted automatically using a speed signal or armature current signal (i.e. load), or both for optimum control.

In road vehicles, the supply is itself dc, and hence needs no rectification. Voltage control is often obtained by an electronic chopper circuit. Choppers may use pulse-width modulation PWM at constant frequency, or pulse-frequency modulation PFM with constant pulse width.

Another effective method for obtaining smooth voltage control is the Ward-Leonard system. The dc motor is fed from a dc generator driven by some prime-mover (eg ac motor

or Diesel engine). By varying the field excitation of the generator, the armature voltage of the motor varied (and can be even reserved). The motor field is fed from an exciter (small dc generator) or rectifier at constant voltage. The Ward-Leonard system is generally more expensive than a solid-state drive, but has compensating advantages for certain applications.

### Armature resistance control

For a given load torque, and hence given current, placing an external resistance in series with the armature, reduces the emf and hence speed. The increasing value of resistance increases the slope of the mechanical c/s, but the intercept remains unchanged. Armature resistance control may also be used with series motors; at heavy loads the machine is saturated and operation approaches that of constant-flux motors with slope increasing as resistance is increased. Armature resistance control is inexpensive and simple to use with small motors, but it is impractical and wastes energy with large motors.

### Field control

This method of speed control may be used with shunt and separately excited motors. If the field circuit resistance is increased, the field current, and hence the main field, will be reduced, and the speed will increase. The higher the field resistance, the higher the intercept and the greater the slope (i.e. the c/s becomes softer).

The flux cannot be reduced indefinitely because the speed becomes too high and may damage the motor. Moreover, if the main field becomes too weak, the demagnetizing effect of armature reaction becomes prominent (relatively large) which may lead to instability.

## 9.7 Starting

At the moment the motor is switched on, it is at standstill, so that there is no induced emf. The entire line voltage is applied across the armature resistance, since we have

$$V = I_{\text{start}} \cdot R_A \quad \text{and} \quad I_{\text{start}} = \frac{V}{R_A}$$

The starting current is therefore very high, especially for large motors which have very small armature circuit resistance. The starting current may be more than 20 times rated value, and would damage the motor unless some means is found to limit it.

Once the motor starts to rotate, the internal emf begins to build up and thus reduce the current in accordance to  $I_A = \frac{V - E}{R_A}$

Note also that the rate at which the emf builds up depends on the rate at which the motor accelerates from standstill which, in turn, depends on the starting torque;

That is , a high starting torque is desirable for rapid initial acceleration (and hence rapid build-up of emf, and hence rapid reduction of the high starting current).

### Direct on-line starting(DOL)

DOL starting means simply connecting the motor to the supply through a switch. This method can be used only with small motors where (a) the armature resistance is high enough to limit the starting current , and (b) the rotor inertia is small enough to allow rapid acceleration ( and hence rapid build-up of emf leading to rapid reduction of current).

### Variable voltage starting

Motors supplied from Ward-Leonard sets or controlled rectifiers can be started by raising the supply voltage gradually from zero. The low initial voltage results in a reduced starting current.

### Resistance starting

This is the most common method of starting dc motors. A specially designed variable resistor is connected in series with the armature, fig. 9.21. When the moving contact is moved from the OFF position to the START position, all sections of the starting resistor are in the circuit so that the starting current is limited to

$$I_{\text{start}} = \frac{V}{R_A + R_{\text{start}}}$$

The value of  $R_{\text{start}}$  is chosen to limit the starting current to a safe value, usually 1.5-2.5 times rated current. Although the starting current is still greater than the rated current, it is considered safe because it flows only for a short time. Moreover , a relatively high current is needed to obtain a high torque for rapid acceleration.

As the motor builds up speed (and hence emf), the starting resistance is cut out section by section until it is totally out of the circuit. During this process, the starting current and the induced emf follow stepped curves of the forms shown in fig.9.22. In principle, a given section is cut out when the current has fallen to some minimum value, say rated current; upon cutting out section, the current will jump up again to a value limited by the sections remaining in the circuit (maximum safe value).

During starting, full voltage must be applied to the shunt field winding to make the flux maximum; this maximizes starting torque and emf, and prevents overspeed (the high starting current may cause severe armature reaction, i.e. reduce the flux). For this reason , the starting resistor is connected in the armature circuit and not in the line, and the field control resistor is shorted out during starting.



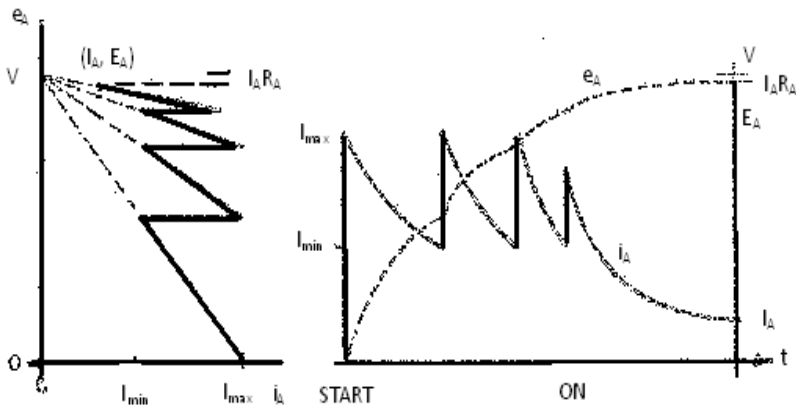

Fig. 9.22

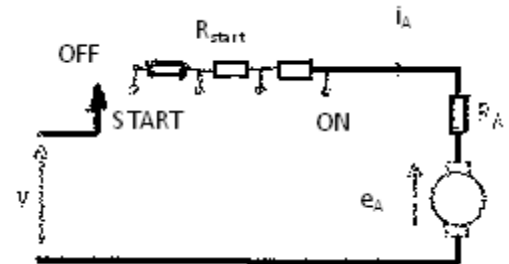

Fig. 9.21 Resistance Starting.

Grading of starting resistance of shunt motors

Either lower value of current may be fixed or the number of starter steps may be fixed.

$$\frac{\text{lower current limit}}{\text{upper current limit}} = \frac{I_{\min}}{I_{\max}}$$

Resistance in the circuit on successive studs from geometrical progression , having a common ratio equal to  $\frac{I_{\min}}{I_{\max}}$

For 4-studs starter:

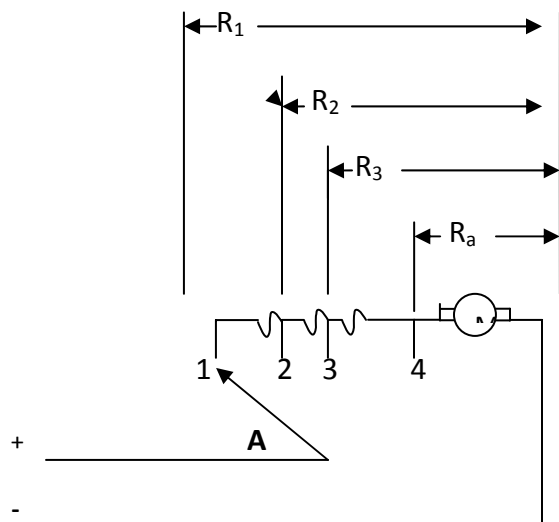

When arm A goes to point 1  $I_A = I_{\max} = \frac{V}{R_1}$  where  $R_1 = R_A + \text{starter resistance}$ .

As the motor speeds up, its emf grows and hence decreases  $I_A$  as shown by the curve in fig.9.22. When current has fallen to predetermined value  $I_{min}$ , arm A is moved to stud No. 2. Let the value of back emf be  $E_{b1}$  at the time of leaving stud No.1. Then

$$I_{min} = \frac{V - E_{b1}}{R_1} \quad \dots\dots\dots(1)$$

When A touches stud No.2, then due to diminution of circuit resistance, the current again jumps up to its previous value  $I_{max}$ . since speed had no time to change, the back emf remains the same as initially.

$$I_{max} = \frac{V - E_{b1}}{R_2} \quad \dots\dots\dots(2)$$

From (1), and (2), we get  $\frac{I_{max}}{I_{min}} = \frac{R_1}{R_2} \quad \dots\dots\dots(3)$

When A is held on stud No.2 for some time, then speed and hence back emf increases to a value  $E_{b2}$ , thereby decreasing the current to previous value  $I_{min}$ , SO THAT

$$I_{min} = \frac{V - E_{b2}}{R_2} \quad \dots\dots\dots(4)$$

Similarly, on first making contact with stud No.3, the current is

$$I_{max} = \frac{V - E_{b2}}{R_3} \quad \dots\dots\dots(5)$$

From (4), and (5), we get  $\frac{I_{max}}{I_{min}} = \frac{R_2}{R_3} \quad \dots\dots\dots(6)$

When A is held on No.3 for some time, the speed and hence back emf increases to a new value  $E_{b3}$ , thereby decreasing the armature current to a value  $I_{max}$  such that

$$I_{min} = \frac{V - E_{b3}}{R_3} \quad \dots\dots\dots(7)$$

On making contact with stud No. 4, current jumps to  $I_{max}$  given by

$$I_{max} = \frac{V - E_{b3}}{R_a} \quad \dots\dots\dots(8)$$

From (7), and (8), we get  $\frac{I_{max}}{I_{min}} = \frac{R_3}{R_a} \quad \dots\dots\dots(9)$

From (3),(6),and (9), it is seen that

$$\frac{I_{max}}{I_{min}} = \frac{R_1}{R_2} = \frac{R_2}{R_3} = \frac{R_3}{R_a} = k \text{ (say)} \quad \dots\dots\dots(10)$$

Obviously,  $R_3 = kR_a$ ,  $R_2 = kR_3 = k^2R_a$

$$R_1 = kR_2 = k^3R_a$$

In general, if  $i$  is the number of live studs and therefore  $(i-1)$  the number of sections in the starter resistance, then

$$R_1 = k^{i-1}R_a \quad \text{or} \quad \frac{R_1}{R_a} = k^{i-1}$$

$$\text{Or} \quad \left(\frac{I_{\max}}{I_{\min}}\right)^{i-1} = k^{i-1}$$

$$\text{or} \quad k^{i-1} = \frac{R_1}{R_a} = \frac{V}{I_{\max}R_a}$$

$$k^i = \frac{V}{I_{\max}R_a} \frac{I_{\max}}{I_{\min}} = \frac{V}{I_{\min}R_a}$$

$$i = 1 + \frac{\log\left(\frac{V}{I_{\max}R_a}\right)}{\log k}$$

since  $R_1 = \frac{V}{I_{\min}}$  and  $R_a$  are usually known and  $k$  is known from the given values of maximum and minimum currents (determined by the load against which motor has to start), the value of  $i$  can be found and hence the value of different starter sections.

## 9.8 Braking

When the electric supply to the motor is switched off, the rotation does not stop immediately, but continues until the kinetic energy of the rotating parts (rotor and load) is dissipated. But in many applications, such as electric trains, vehicles, cranes, and lifts, the motor must be stopped quickly, and hence some form of braking is required at switch-off.

### External braking

Quick braking can be achieved by an external friction brake mounted on the shaft and operated by a solenoid (electromagnet). At the instant the supply is switched off, the brake is applied to stop rotation. In effect, the kinetic energy of the rotating parts is dissipated quickly as heat in the brake pads.

The eddy-current brake is another type of external brake. It is made up of a conducting disc mounted on the shaft, and a set of stationary coils adjacent to the disc. At the instant the supply to the motor is switched off, the brake coils are energized to induce eddy currents in the rotating disc. The field of the coils and the currents of the disc produce a torque that opposes

rotation(generator action) and hence slows the shaft rapidly. In effect, the kinetic energy of the rotating parts is dissipated as heat in the disc of the brake.

### Electric braking

Instead of using an external brake, it is sometimes possible to use the properties of the dc machine itself to achieve quick braking, or to assist in braking.

In dynamic braking (or rheostatic braking), a resistor (possibly the starting resistor itself) is connected across the armature terminals at the instant it is disconnected from the supply. With the shunt field still excited, the machine acts as a generator loaded by the resistor; the armature current reverses, and the developed torque now opposes rotation. In effect, the kinetic energy is dissipated as heat mainly in the resistor, but also in the armature wdg. During braking, it is preferable to energize the field from the line and not from the armature; otherwise, braking action stops when the speed falls below the critical value.

A dc motor is said to be regenerating when its emf exceeds the applied voltage so that the armature current reverses and the machine becomes a generator that returns electrical power to the supply; the source of the power is the kinetic energy of the rotating parts, and hence regeneration slows the motor down. Regenerative braking uses this principle to aid in stopping the motor or in slowing it down; regeneration is achieved by strengthening the field or by reducing the applied voltage. The main advantage of regenerative braking is the saving of energy, which is returned to the supply and not dumped as heat as in the other methods of braking. It is often used in electric trains to exploit downhill runs, and in cranes to exploit the descending part of the duty cycle. Regenerative braking can be used only if the electric supply is capable of accepting electrical energy from the motor (eg chargeable batteries or dc mains); standard controlled rectifiers cannot accept electrical power from the motor unless they are modified for the purpose (eg by the inclusion of inverters). In regenerative braking, the braking action stops when the speed becomes low enough to reduce the emf below the terminal voltage.

A strong braking effect down to zero speed is obtained by plugging(or counter-current braking). The supply connections to the armature are reversed , so that the supply and armature emf act as series sources aiding each other to circulate a heavy counter-current

$$I_A = \frac{E_A + V}{R}$$

The machine operates in the generating mode with a heavy current, and hence with a strong braking torque. A series limiting resistor is inserted in the circuit to avoid damaging currents; if the starting resistor is used , the plugging current will be twice starting current(i.e. up to 5 times rated current). During plugging, the kinetic energy of the rotating parts plus heavy power from

the supply ( $V_A$ ) are dissipated in the armature winding and the limiting resistor. The supply must be disconnected from the motor at the instant the speed reaches zero, otherwise the motor will run in the reverse direction. Plugging involves such heavy currents and high mechanical stresses that it is used only with small motors.

### 9.9 Modes of operation

The four –quadrant diagram helps clarify the various modes of operation of a dc motor. The first quadrant corresponds to standard motor operation in one direction, while the third quadrant corresponds to motor operation in the reverse direction. The second and fourth quadrants correspond to generator operation.

Taking the 1<sup>st</sup> Q as reference, it is seen that motor operation in the reverse direction, 3<sup>rd</sup> Q, requires reversal of either the applied voltage or the field current. If both are reversed at the same time, motor operation will continue in the same direction, 1<sup>st</sup> Q.

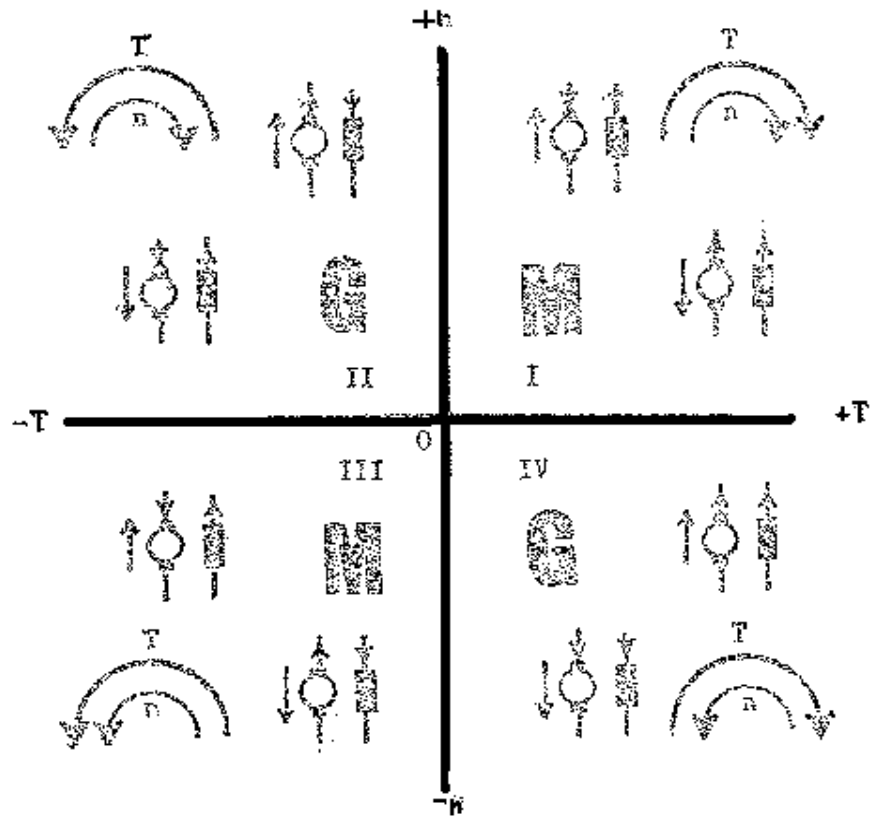

If initial operation is in the 1<sup>st</sup> Q, then the 2<sup>nd</sup> Q corresponds to dynamic or regenerative braking. Plugging also shifts operation to the 2<sup>nd</sup> Q, but attempts to continue to the 3<sup>rd</sup>; the supply is disconnected when the operating point passes through zero speed. If initial operation is in the 3<sup>rd</sup> Q, i.e. in the reverse direction, then dynamic braking, regenerative braking, and plugging occur in the 4<sup>th</sup> Q.

For example, if the motor is used in lifts or cranes, we have:

Quadrant I : motor raises load;

Quadrant III: motor lowers load;

Quadrant II : motor brakes upward(inertia) motion of load;

Quadrant IV: load moves down by its own weight while motor applies a braking torque to keep speed constant.

### 9.10 Applications

DC motors are less common than ac motors because ac motors are cheaper, more robust, and require less maintenance, and because standard mains are ac. However, there are two main types of application for which dc motors are more suitable than ac motors: battery-operated equipment (think about motors used in vehicles), and applications requiring accurate or flexible control of speed or torque.

Battery-operated equipment includes small portable apparatus (such as DVD players, cassette recorders, etc), cordless tools, and toys, as well as electric drives in road vehicles. These are usually permanent magnet or shunt (fixed –excitation) motors, but occasionally series motors. The high starting torque of the series motor makes it suitable for self-starter duty in cars. Electric vehicles employ permanent magnet or series motors, with speed control by means of choppers (armature voltage control) or armature series resistance.

The accurate control of dc motors makes them suitable for servomotor duty in automatic control systems. The motors in such applications generally have small power rating (less than 1 KW), and are required to drive a load in accordance with a control signal applied to the armature (armature voltage control). They are usually constant field motors (PM or separately-excited) designed to have a low moment of inertia for quick response, and linear mechanical characteristics for accurate control.

The flexibility of control of dc motors makes them suitable for certain heavy power applications such as lifts, cranes, hoists, and electric traction (electric trains), as well as certain drives in heavy industry. These applications can involve frequent changes in speed, stops and starts, and possibly reversals. The hard  $c/s$ 's of shunt motors with armature voltage control are ideal for adjustable speed drives, while the softer  $c/s$ 's of compound and series motors are sometimes exploited in traction (locomotives) to do without different gear ratios.